

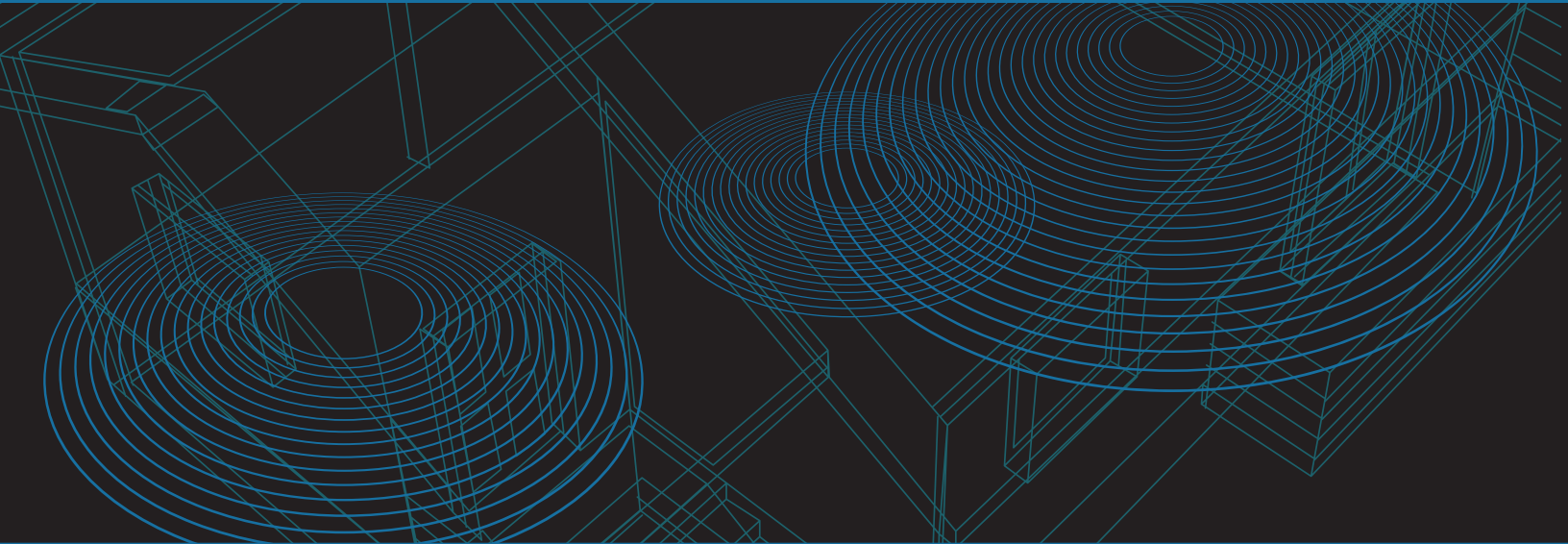

Outdoor Wireless-1750AC Managed Access Point Pro

HOW17ACM



website [www.hawkingtech.com](http://www.hawkingtech.com)  
e-mail [techsupport@hawkingtech.com](mailto:techsupport@hawkingtech.com)

**USER'S MANUAL** ▶▶

## **COPYRIGHT**

Copyright ©2017 by Hawking Technologies. All rights reserved. No part of this publication may be reproduced, transmitted, transcribed, stored in a retrieval system, or translated into any language or computer language, in any form or by any means, electronic, mechanical, magnetic, optical, chemical, manual or otherwise, without the prior written permission of this company

Hawking Technologies makes no representations or warranties, either expressed or implied, with respect to the contents hereof and specifically disclaims any warranties, merchantability or fitness for any particular purpose. Any software described in this manual is sold or licensed "as is". Should the programs prove defective following their purchase, the buyer (and not Hawking Technologies, its distributor, or its dealer) assumes the entire cost of all necessary servicing, repair, and any incidental or consequential damages resulting from any defect in the software. Further, this company reserves the right to revise this publication and to make changes from time to time in the contents thereof without obligation to notify any person of such revision or changes.

**Federal Communication Commission  
Interference Statement**

**FCC Part 15**

This equipment has been tested and found to comply with the limits for a Class B digital device, pursuant to Part 15 of FCC Rules. These limits are designed to provide reasonable protection against harmful interference in a residential installation. This equipment generates, uses, and can radiate radio frequency energy and, if not installed and used in accordance with the instructions, may cause harmful interference to radio communications. However, there is no guarantee that interference will not occur in a particular installation. If this equipment does cause harmful interference to radio or television reception, which can be determined by turning the equipment off and on, the user is encouraged to try to correct the interference by one or more of the following measures:

1. Reorient or relocate the receiving antenna.
2. Increase the separation between the equipment and receiver.
3. Connect the equipment into an outlet on a circuit different from that to which the receiver is connected.
4. Consult the dealer or an experienced radio technician for help.

**FCC Caution**

This equipment must be installed and operated in accordance with provided instructions and a minimum 20 cm spacing must be provided between computer mounted antenna and person's body (excluding extremities of hands, wrist and feet) during wireless modes of operation.

This device complies with Part 15 of the FCC Rules. Operation is subject to the following two conditions: (1) this device may not cause harmful interference, and (2) this device must accept any interference received, including interference that may cause undesired operation.

Any changes or modifications not expressly approved by the party responsible for compliance could void the authority to operate equipment.

**Federal Communication Commission (FCC) Radiation Exposure Statement**

This equipment complies with FCC radiation exposure set forth for an uncontrolled environment. In order to avoid the possibility of exceeding the FCC radio frequency exposure limits, human proximity to the antenna shall not be less than 20cm (8 inches) during normal operation.

The antenna(s) used for this transmitter must not be co-located or operating in conjunction with any other antenna or transmitter.

### **R&TTE Compliance Statement**

This equipment complies with all the requirements of DIRECTIVE 1999/5/EC OF THE EUROPEAN PARLIAMENT AND THE COUNCIL of March 9, 1999 on radio equipment and telecommunication terminal Equipment and the mutual recognition of their conformity (R&TTE).

The R&TTE Directive repeals and replaces in the directive 98/13/EEC (Telecommunications Terminal Equipment and Satellite Earth Station Equipment) As of April 8, 2000.

### **Safety**

This equipment is designed with the utmost care for the safety of those who install and use it. However, special attention must be paid to the dangers of electric shock and static electricity when working with electrical equipment. All guidelines of this and of the computer manufacture must therefore be allowed at all times to ensure the safe use of the equipment.

### **EU Countries Intended for Use**

The ETSI version of this device is intended for home and office use in Austria, Belgium, Denmark, Finland, France, Germany, Greece, Ireland, Italy, Luxembourg, the Netherlands, Portugal, Spain, Sweden, and the United Kingdom.

The ETSI version of this device is also authorized for use in EFTA member states: Iceland, Liechtenstein, Norway, and Switzerland.

### **EU Countries Not intended for use**

None.

## CONTENTS

<b>Chapter 1 - Product Information.....</b>	<b>2</b>
1-1. Package Contents .....	2
1-2. System Requirements.....	3
1-3. Hardware Overview.....	3
1-4. LED Status.....	3
1-5. Reset.....	4
1-6. Methods of Mounting .....	4
1-7. Safety Information.....	7
<b>Chapter 2 - Quick Setup .....</b>	<b>8</b>
2-1. Initial Setup.....	8
2-2. Quick Setup Settings.....	11
<b>Chapter 3 - Hardware Installation .....</b>	<b>14</b>
3-1. Connecting the access point to a router or PoE switch .....	14
<b>Chapter 4 - Browser Based Configuration Interface .....</b>	<b>15</b>
4-1. Information.....	18
4-1-1. System Information.....	18
4-1-2. Wireless Clients .....	22
4-1-3. Wireless Monitor.....	24
4-1-4. DHCP Clients.....	25
4-1-5. Log .....	25
4-2. Network Settings .....	28
4-2-1. LAN-Side IP Address .....	28
4-2-2. LAN Port .....	30
4-2-3. VLAN .....	31
4-3. Wireless Settings .....	32
4-3-1. 2.4GHz 11bgn .....	32
4-3-2. 5GHz 11ac 11an.....	45
4-3-3. WPS .....	51
4-3-4. RADIUS .....	53
4-3-5. MAC Filter.....	55
4-3-6. WMM .....	57
4-4. Management .....	59
4-4-1. Admin .....	59
4-4-2. Date and Time .....	62

4-4-3.	Syslog Server .....	64
4-4-4.	I'm Here .....	65
4-5.	Advanced .....	66
4-5-1.	LED Settings.....	66
4-5-2.	Update Firmware .....	67
4-5-3.	Save/Restore Settings .....	69
4-5-4.	Factory Default.....	71
4-5-5.	Reboot.....	72

## **Chapter 5 - Appendix .....73**

5-1.	Configuring your IP address .....	73
5-1-1.	Windows 7.....	74
5-1-2.	Windows 8.1.....	77
5-1-3.	Windows 10.....	80
5-1-4.	Mac.....	82
5-2.	Hardware Specification .....	84
5-3.	Environmental and Physical .....	84

1-1. Package Contents

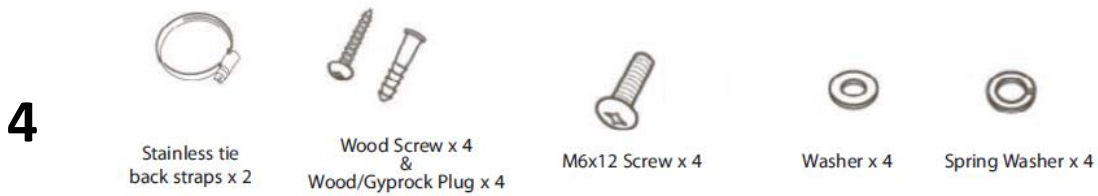
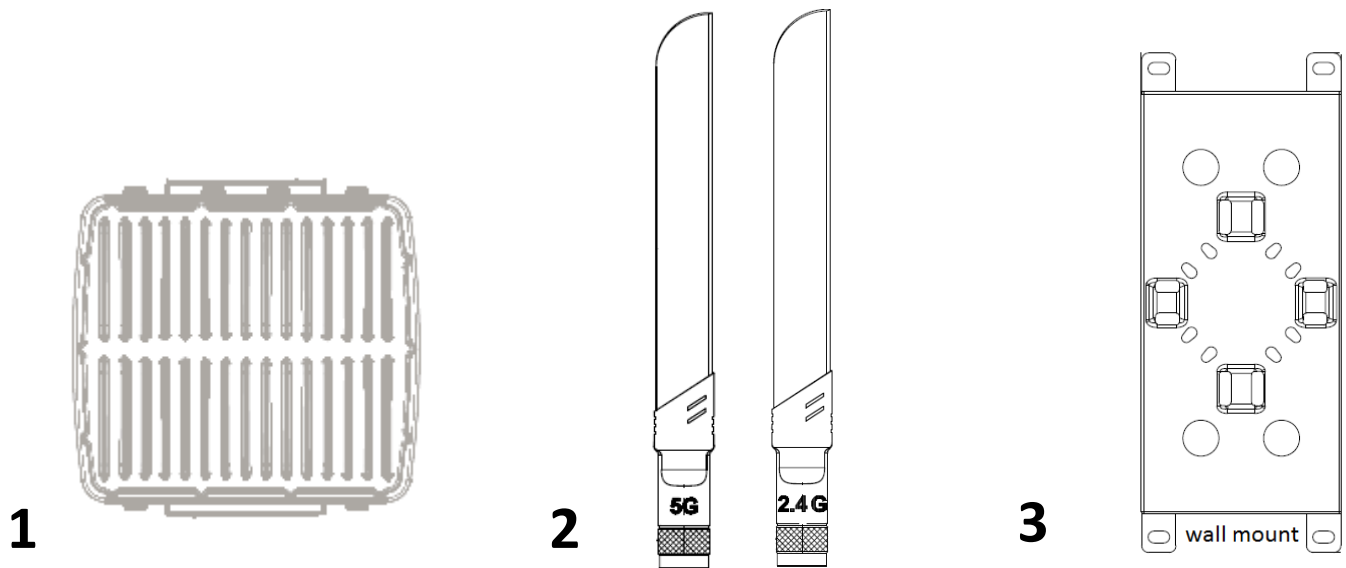

- 1. HOW17ACM
- 2. 6x Omnidirectional Antennas  
(3x 2.4GHz 4dBi, 3x 5GHz 6dBi)
- 3. Wall Mount Bracket x 1
- 4. Wall/Pole Mount Screw Kits
- 5. Quick Installation Guide

## 1-2. System Requirements

- Existing cable/DSL modem & router
- Computer with web browser for access point configuration
- Power Over Ethernet Switch or Injector (sold separately)

## 1-3. Hardware Overview

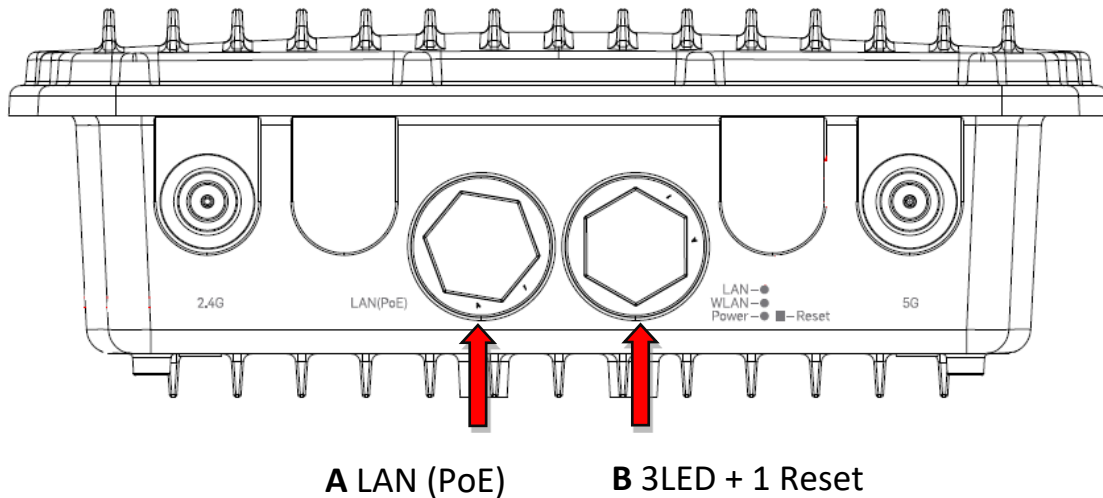

- A. LAN port with Power over Ethernet (PoE PD-IN)
- B. 3LED + 1 Reset M25 interface

## 1-4. LED Status

LED Behavior		
Power	Green	The access point is on.
	Off	The access point is off.
LAN LED	Green	LAN port is connected.
	Blinking	Activity (transferring and receiving)
	Off	LAN port is unconnected.



<b>Wireless LED</b>	<b>Green</b>	Wireless Enable.
	Blinking	Activity (transferring and receiving)
	Off	Wireless Disable.

### 1-5. Reset

If you experience problems with your access point, you can reset the device back to its factory settings. This resets **all** settings back to default.

1. Press and hold the reset button on the access point for at least 20 seconds then release the button.



***You may need to use a pin or similar sharp object to push the reset button.***

2. Wait for the access point to restart. The access point is ready for setup when the LED is **green**.

### 1-6. Methods of Mounting

The access point includes wall / pole mount which requires some assembly.

1. Attach the wall mount bracket to back of AP using M6x12 screws and washers, as shown below.



***Ensure your access point is securely attached to the wall mount bracket.***

## Wall Mount:

### 1.Vertical

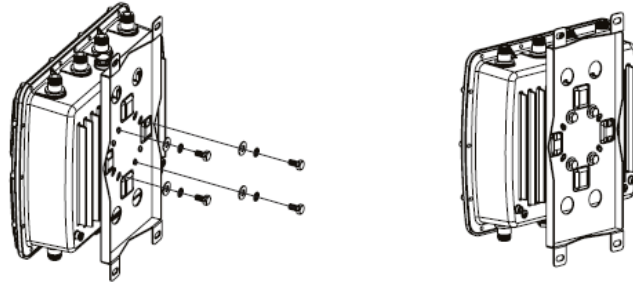

### 2.Horizontal

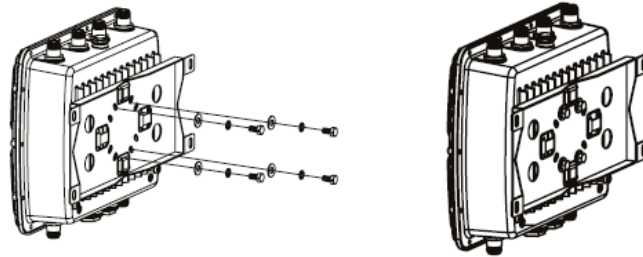

**2.** Fix the wall mount with AP to the wall using wood/gyprock screws.

## Mounting For Wall

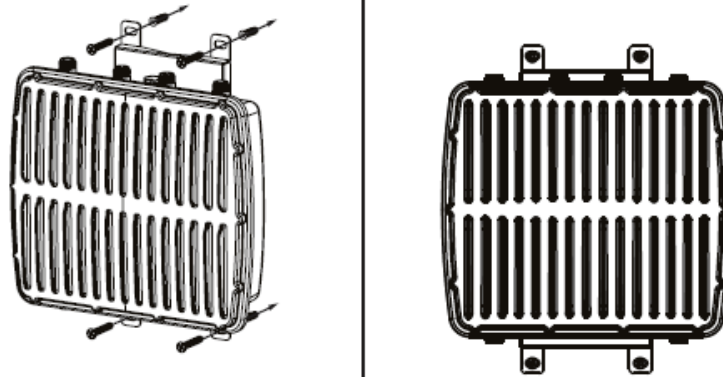

**3.** Fix the wall mount with AP to the pole using stainless tie back straps.

# Mounting For Pole

Type 1

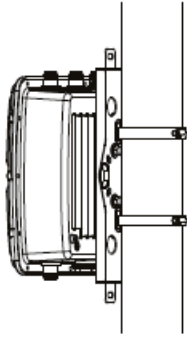

Type 2

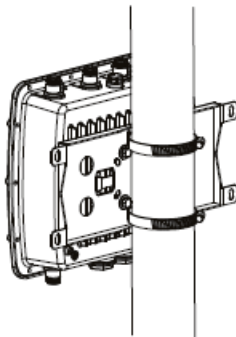

Type 3

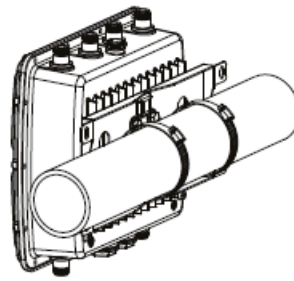

## 1-7. Safety Information

In order to ensure the safe operation of the device and its users, please read and act in accordance with the following safety instructions.

1. The access point is designed for indoor use only; do not place the access point outdoors.
2. Do not place the access point in or near hot/humid places, such as a kitchen or bathroom.
3. Do not pull any connected cable with force; carefully disconnect it from the access point.
4. Handle the access point with care. Accidental damage will void the warranty of the access point.
5. The device contains small parts which are a danger to small children under 3 years old. Please keep the access point out of reach of children.
6. Do not place the access point on paper, cloth, or other flammable materials. The access point may become hot during use.
7. There are no user-serviceable parts inside the access point. If you experience problems with the access point, please contact your dealer of purchase and ask for help.
8. The access point is an electrical device and as such, if it becomes wet for any reason, do not attempt to touch it without switching the power supply off. Contact an experienced electrical technician for further help.
9. If you smell burning or see smoke coming from the access point or power adapter, then disconnect the access point and power adapter immediately, as far as it is safely possible to do so. Call your dealer of purchase for help.

Your access point can be up and running in just a few minutes. This quick installation guide will help to set up your access point and configure its basic settings. Please follow the instructions in the chapters below:

### 2-1. Initial Setup

1. Connect the access point to a PoE Switch or PoE Injector via Ethernet cable which can supply power and data out.

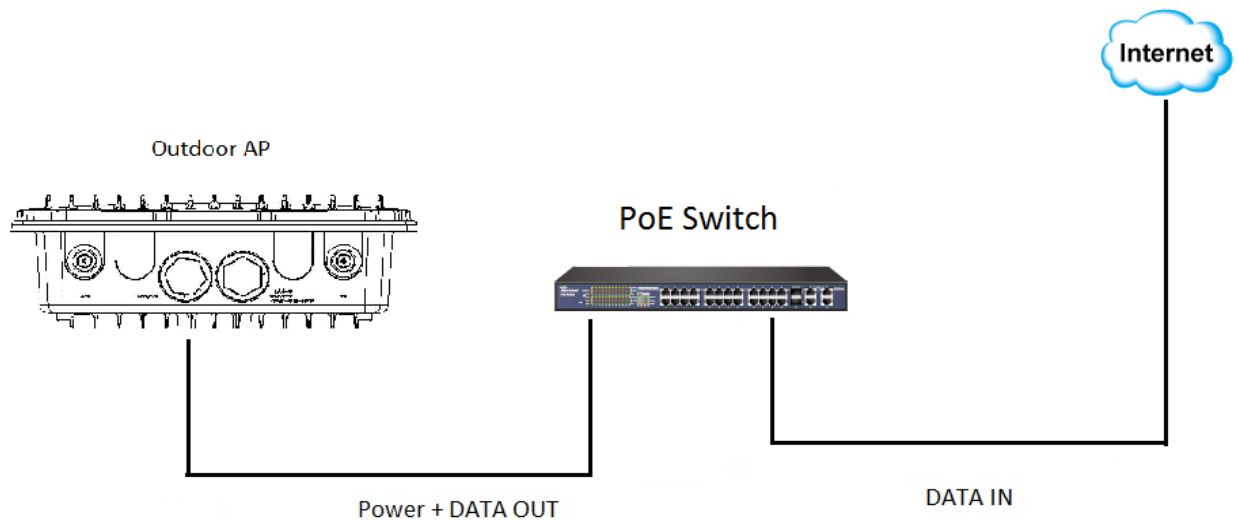

2. Please wait a moment for the access point to start up. The access point is ready when the LED is **green**.
3. Set your computer's IP address to **192.168.1.x** where **x** is a number in the range **1 – 100**. If you are unsure how to do this, please refer to the Chapter 5-1.



***Please ensure there are no other active network connections on your computer (disconnect Wi-Fi connections and Ethernet cables).***

4. Enter the access point's default IP address **192.168.1.230** into the URL bar of a web browser.

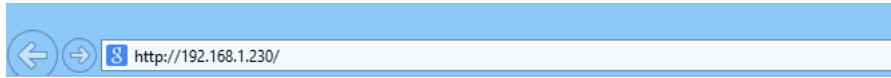

- 5.** You will be prompted for a username and password. Enter the default username “admin” and the default password “1234”.



- 6.** You will arrive the “Quick Setup” screen shown below.

### 2.4GHz Basic Settings

Wireless	<input checked="" type="radio"/> Enable <input type="radio"/> Disable
Band	11b/g/n ▾
SSID1	Hawking_HOW17ACM_2. VLAN ID 1
Auto Channel	<input checked="" type="radio"/> Enable <input type="radio"/> Disable
Auto Channel Range	Ch 1 - 11 ▾
Auto Channel Interval	One day ▾ <input type="checkbox"/> Change channel even if clients are connected
Channel Bandwidth	Auto ▾
BSS BasicRateSet	1,2,5.5,11 Mbps ▾

### 5GHz Basic Settings

Wireless	<input checked="" type="radio"/> Enable <input type="radio"/> Disable
Band	11a/n/ac ▾
SSID1	Hawking_HOW17ACM_5. VLAN ID 1
Auto Channel	<input checked="" type="radio"/> Enable <input type="radio"/> Disable
Auto Channel Range	Band 1 ▾
Auto Channel Interval	One day ▾

- Next, please follow the instructions below in **2-2. Quick Setup** to configure the access point's basic settings.



***For more advanced configurations, please refer to Chapter 4. Browser Based Configuration Interface.***

## 2-2. Quick Setup Settings

The instructions below will help you to configure the following basic settings of the access point:

- 1 **2.4GHz & 5GHz SSID LAN IP Address**
- 2 **LAN IP Address**
- 3 **2.4GHz & 5GHz SSID Security**



***It is recommended you configure these settings before using the access point.***

1. To change the SSID of your access point's 2.4GHz wireless network(s), go to "2.4GHz Basic Settings". Enter the new SSID for your 2.4GHz wireless network in the "SSID1" field". The default 2.4GHz SSID is "Hawking\_HOW17ACM\_5GHz"



***To utilize multiple 2.4GHz SSIDs, open the drop down menu labelled "Enable SSID number" and select how many SSIDs you require. Then enter a new SSID in the corresponding numbered fields below, before clicking "Apply".***

2.4GHz Basic Settings	
Wireless	<input checked="" type="radio"/> Enable <input type="radio"/> Disable
Band	11b/g/n ▾
SSID1	Hawking_HOW17ACM_2. VLAN ID 1
Auto Channel	<input checked="" type="radio"/> Enable <input type="radio"/> Disable
Auto Channel Range	Ch 1 - 11 ▾
Auto Channel Interval	One day ▾ <input type="checkbox"/> Change channel even if clients are connected
Channel Bandwidth	Auto ▾
BSS BasicRate Set	1,2,5.5,11 Mbps ▾

2. Go to "5GHz Basic Settings" and repeat step 1 for the access point's 5GHz AC wireless network. The default 5GHz SSID is "Hawking\_HOW17ACM\_5GHz"



5GHz Basic Settings	
Wireless	<input checked="" type="radio"/> Enable <input type="radio"/> Disable
Band	11a/n/ac ▾
SSID1	Hawking_HOW17ACM_5t VLAN ID 1
Auto Channel	<input checked="" type="radio"/> Enable <input type="radio"/> Disable
Auto Channel Range	Band 1 ▾
Auto Channel Interval	One day ▾ <input type="checkbox"/> Change channel even if clients are connected
Channel Bandwidth	Auto 80/40/20 MHz ▾
BSS BasicRate Set	6,12,24 Mbps ▾

- 3.** To change the access point's LAN IP address, go to "LAN-side IP Address" and you will see the screen below.

LAN-side IP Address	
IP Address Assignment	Static IP Address ▾
IP Address	10.1.1.80
Subnet Mask	255.255.255.0
Default Gateway	User-Defined ▾ 10.1.1.1
LAN-side DNS Servers	
Primary Address	User-Defined ▾ 10.1.1.1
Secondary Address	User-Defined ▾

- 4.** Enter the IP address settings you wish to use for your access point. You can use a dynamic (DHCP) or static IP address, depending on your network environment. Click "Next" to save the changes and to go to the security settings.



***When you change your access point's IP address, you need to use the new IP address to access the browser based configuration interface instead of the default IP 192.168.1.230.***

- 5.** To configure the security of your access point's 2.4GHz wireless network(s), go to **"2.4GHz Wireless Security Settings"**. Select an "Authentication Method" and enter a "Pre-shared Key" or "Encryption Key" depending on your choice, then click "Apply". Hawking recommends at least WPA/WPA2 security.



*If using multiple SSIDs, specify which SSID to configure using the "SSID" drop down menu.*

2.4GHz Wireless Security Settings	
SSID	Hawking_HOW17ACM_2.4GHz ▾
Broadcast SSID	Enable ▾
Wireless Client Isolation	Disable ▾
Load Balancing	50 /50
Authentication Method	WPA-PSK ▾
WPA Type	WPA/WPA2 Mixed Mode-PSK ▾
Encryption Type	TKIP/AES Mixed Mode ▾
Key Renewal Interval	60 minute(s)
Pre-shared Key Type	Passphrase ▾
Pre-shared Key	*****
Additional Authentication	No additional authentication ▾

- 6.** Go to **"Wireless Setting" > "5GHz 11ac 11an"** and repeat steps 5 for the access point's 5GHz wireless network. Click "Apply" and the device will now reset and save your settings.
- 7.** The basic settings of your access point are now configured. Please refer to **Chapter 3 - Hardware Installation** for guidance on connecting your access point to a router or PoE switch.

### 3-1. Connecting the access point to a router or PoE switch

Connect a router (with PoE Injector) or PoE switch to the access point's **LAN** port using an Ethernet cable. PoE switches **must** be connected to the access point's **LAN** port.

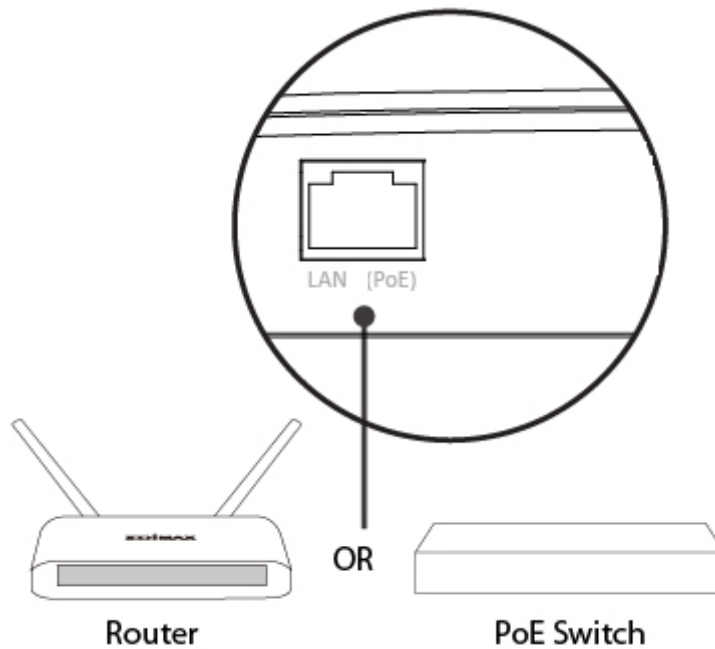

## Chapter 4 - Browser Based Configuration Interface

---

The browser-based configuration interface enables you to configure the access point's advanced features. The device features a range of advanced functions such as MAC filtering, MAC RADIUS authentication, VLAN configurations, up to 32 SSIDs and many more. To access the browser based configuration interface:

- 1.** Connect a computer to your access point using an Ethernet cable.
- 2.** Enter your access point's IP address in the URL bar of a web browser (as configured in Chapter 2-2. The access point's default IP address is **192.168.1.230**).
- 3.** You will be prompted for a username and password. The default username is "admin" and the default password is "1234", though it was recommended that you change the password during setup (see **Chapter 2-2 Basic Settings**).



***If you cannot remember your password, reset the access point back to its factory default settings. Refer to Chapter 1-5 Reset***

- 4.** You will arrive at the "Settings" screen shown below.

**2.4GHz Basic Settings**

Wireless	<input checked="" type="radio"/> Enable <input type="radio"/> Disable
Band	11b/g/n ▾
SSID1	Hawking_HOW17ACM_2. VLAN ID 1
Auto Channel	<input checked="" type="radio"/> Enable <input type="radio"/> Disable
Auto Channel Range	Ch 1 - 11 ▾
Auto Channel Interval	One day ▾ <input type="checkbox"/> Change channel even if clients are connected
Channel Bandwidth	Auto ▾
BSS BasicRateSet	1,2,5.5,11 Mbps ▾

**5GHz Basic Settings**

Wireless	<input checked="" type="radio"/> Enable <input type="radio"/> Disable
Band	11a/n/ac ▾
SSID1	Hawking_HOW17ACM_5. VLAN ID 1
Auto Channel	<input type="radio"/> Enable <input checked="" type="radio"/> Disable
Channel	Ch 149, 5.745GHz ▾
Channel Bandwidth	Auto 80/40/20 MHz ▾

**5.** Use the menu across the top and down the left side to navigate.

The screenshot shows the Hawking Technology web interface. At the top, there is a navigation bar with the logo and links for Home, Logout, and Global (English). Below this is a main menu with options: HOW17ACM, Quick Setup, Information, Network Settings, Wireless Settings, Management, and Advanced. The 'Wireless Settings' section is expanded, showing a sidebar with options for 2.4GHz 11bgn, 5GHz 11ac 11an, WPS, RADIUS, MAC Filter, and WMM. The 'Basic' sub-tab is selected under 2.4GHz 11bgn. The main content area shows the 'Basic Settings' for the wireless network. The 'Wireless' checkbox is checked (Enable). The 'Band' is set to '11b/g/n'. The 'Enable SSID number' is set to '1'. The 'SSID1' is 'HOW17ACM\_2.4GHz' and the 'VLAN ID' is '1'. The 'Auto Channel' checkbox is unchecked (Disable). The 'Channel' is 'Ch 11, 2462MHz'. The 'Channel Bandwidth' is 'Auto, +Ch 7'. The 'BSS BasicRate Set' is '1,2,5,5,11 Mbps'. At the bottom right, the 'Apply' and 'Cancel' buttons are visible, with 'Apply' circled in red. Red arrows point to the 'Basic' tab and the 'Apply' button.

6. Click “Apply” to save changes and reload the access point, or “Cancel” to cancel changes.



***Please wait a few seconds for the access point to reload after you “Apply” changes, as shown below.***

Configuration is complete. Reloading now... Please wait for  seconds.

7. Please refer to the following chapters for full descriptions of the browser based configuration interface features.

## 4-1. Information



*Screenshots displayed are examples. The information shown on your screen will vary depending on your configuration.*

### 4-1-1. System Information

#### • System Information

The "System Information" page displays basic system information about the access point.

System	
Model	HOW17ACM
Product Name	HOW17ACM
Uptime	0 day 02:15:50
System Time	2012/01/01 02:15:49
Boot from	Internal memory
Firmware Version	1.0.0
MAC Address	74:DA:38:5E:46:98
Management VLAN ID	1
IP Address	10.1.1.130
Default Gateway	---
DNS	---
DHCP Server	---

### Wired LAN Port Settings

Wired LAN Port	Status	VLAN Mode/ID
LAN1	Connected (100 Mbps Full-Duplex)	Untagged Port / 1

### Wireless 2.4GHz

Status	Enabled
MAC Address	74:DA:38:5E:46:98
Channel	Ch 11
Transmit Power	10%

### Wireless 2.4GHz /SSID

SSID	Authentication Method	Encryption Type	VLAN ID	Additional Authentication	Wireless Client Isolation
HOW17ACM_2.4GHz	WPA/WPA2-PSK	TKIP/AES Mixed Mode	1	No additional authentication	Disabled

### Wireless 2.4GHz /WDS Disabled

MAC Address	Encryption Type	VLAN Mode/ID
No WDS entries.		



Wireless 5GHz	
Status	Enabled
MAC Address	74:DA:38:5E:46:99
Channel	Ch 149 + 153 + 157 + 161
Transmit Power	10%

Wireless 5GHz /SSID					
SSID	Authentication Method	Encryption Type	VLAN ID	Additional Authentication	Wireless Client Isolation
HOW17ACM_5GHz	WPA/WPA2-PSK	TKIP/AES Mixed Mode	1	No additional authentication	Disabled

Wireless 5GHz /WDS Disabled		
MAC Address	Encryption Type	VLAN Mode/ID
No WDS entries.		

Refresh

System	
<b>Model</b>	Displays the model number of the access point.
<b>Product Name</b>	Displays the product name for reference, which consists of “AP” plus the MAC address.
<b>Uptime</b>	Displays the total time since the device was turned on.
<b>Boot From</b>	Displays information for the booted hardware
<b>Version</b>	Displays the firmware version.
<b>MAC Address</b>	Displays the access point’s MAC address.
<b>Management VLAN ID</b>	Displays the management VLAN ID.
<b>IP Address</b>	Displays the IP address of this device. Click “Refresh” to update this value.
<b>Default Gateway</b>	Displays the IP address of the default gateway.
<b>DNS</b>	IP address of DNS (Domain Name Server).
<b>DHCP Server</b>	IP address of DHCP Server.

Wired LAN Port Settings

<b>Wired LAN Port</b>	Specifies which LAN port.
<b>Status</b>	Displays the status of the LAN port (connected or disconnected).
<b>VLAN Mode/ID</b>	Displays the VLAN mode (tagged or untagged) and VLAN ID for the LAN port. See <b>4-2-3. VLAN</b>

<b>Wireless 2.4GHz (5GHz)</b>	
<b>Status</b>	Displays the status of the 2.4GHz or 5GHz wireless (enabled or disabled).
<b>MAC Address</b>	Displays the access point's MAC address.
<b>Channel</b>	Displays the channel number the specified wireless frequency is using for broadcast.
<b>Transmit Power</b>	Displays the wireless radio transmit power level as a percentage.

<b>Wireless 2.4GHz (5GHz) / SSID</b>	
<b>SSID</b>	Displays the SSID name(s) for the specified frequency.
<b>Authentication Method</b>	Displays the authentication method for the specified SSID. See <b>4-3. Wireless Settings</b>
<b>Encryption Type</b>	Displays the encryption type for the specified SSID. See <b>4-3. Wireless Settings</b>
<b>VLAN ID</b>	Displays the VLAN ID for the specified SSID. See <b>4-2-3. VLAN</b>
<b>Additional Authentication</b>	Displays the additional authentication type for the specified SSID. See <b>4-3. Wireless Settings</b>
<b>Wireless Client Isolation</b>	Displays whether wireless client isolation is in use for the specified SSID. See <b>4-2-3. VLAN</b>

<b>Wireless 2.4GHz (5GHz) / WDS Status</b>	
<b>MAC Address</b>	Displays the peer access point's MAC address.
<b>Encryption Type</b>	Displays the encryption type for the specified WDS. See <b>4-3-1-4. WDS</b>
<b>VLAN Mode/ID</b>	Displays the VLAN ID for the specified WDS. See <b>4-3-1-4. WDS</b>

<b>Refresh</b>	Click to refresh all information.
----------------	-----------------------------------

## 4-1-2. Wireless Clients

### • Wireless Clients

The “Wireless Clients” page displays information about all wireless clients connected to the access point on the 2.4GHz or 5GHz frequency.

Refresh time	
Auto Refresh time	<input checked="" type="radio"/> 5 seconds <input type="radio"/> 1 second <input type="radio"/> Disable
Manual Refresh	<input type="button" value="Refresh"/>

2.4GHz WLAN Client Table								
#	SSID	MAC Address	Tx	Rx	Signal (%)	Connected Time	Idle Time	
No wireless client								

5GHz WLAN Client Table								
#	SSID	MAC Address	Tx	Rx	Signal (%)	Connected Time	Idle Time	
No wireless client								

Refresh time	
<b>Auto Refresh Time</b>	Select a time interval for the client table list to automatically refresh.
<b>Manual Refresh</b>	Click refresh to manually refresh the client table.

2.4GHz (5GHz) WLAN Client Table	
<b>SSID</b>	Displays the SSID which the client is connected to.
<b>MAC Address</b>	Displays the MAC address of the client.
<b>Tx</b>	Displays the total data packets transmitted by the specified client.
<b>Rx</b>	Displays the total data packets received by the specified client.
<b>Signal (%)</b>	Displays the wireless signal strength for the specified client.
<b>Connected Time</b>	Displays the total time the wireless client has been connected to the access point.

<b>Idle Time</b>	Client idle time is the time for which the client has not transmitted any data packets i.e. is idle.
<b>Vendor</b>	The vendor of the client's wireless adapter is displayed here.

### 4-1-3. Wireless Monitor

#### • Wireless Monitor

Wireless Monitor is a tool built into the access point to scan and monitor the surrounding wireless environment. Select a frequency and click “Scan” to display a list of all SSIDs within range along with relevant details for each SSID.

**Wireless Monitor**

Site Survey	<input checked="" type="radio"/> Wireless 2.4G/ 5G <input type="radio"/> 2.4G <input type="radio"/> 5G <span style="float: right; margin-left: 10px;"><input type="button" value="Scan"/></span>
Channel Survey result	<input type="button" value="Export"/>

**Wireless 2.4GHz**

Ch	SSID	MAC Address	Security	Signal (%)	Type
You can click Scan button to start.					

**Wireless 5GHz**

Ch	SSID	MAC Address	Security	Signal (%)	Type
You can click Scan button to start.					

Wireless Monitor	
<b>Site Survey</b>	Select which frequency (or both) to scan, and click “Scan” to begin.
<b>Channel Survey Result</b>	After a scan is complete, click “Export” to save the results to local storage.

Site Survey Results	
<b>Ch</b>	Displays the channel number used by the specified SSID.
<b>SSID</b>	Displays the SSID identified by the scan.
<b>MAC Address</b>	Displays the MAC address of the wireless router/access point for the specified SSID.
<b>Security</b>	Displays the authentication/encryption type of the specified SSID.
<b>Signal (%)</b>	Displays the current signal strength of the SSID.

<b>Type</b>	Displays the 802.11 wireless networking standard(s) of the specified SSID.
<b>Vendor</b>	Displays the vendor of the wireless router/access point for the specified SSID.

#### 4-1-4. DHCP Clients

##### • DHCP Clients

This table shows the assigned IP address, MAC Addresses and expiration time for each DHCP leased client.

DHCP Client Table		
IP Address	MAC Address	Expiration Time
No DHCP client		

Refresh

#### 4-1-5. Log

##### • Log

The system log displays system operation information such as up time and connection processes. This information is useful for network administrators.



***When the log is full, old entries are overwritten.***

```

Jan 3 16:02:50 [SYSTEM]: WLAN[5G], Best channel selection start, switch to channel 36 + 40 + 44 + 48
Jan 3 16:02:32 [SYSTEM]: LAN, Port[0] link is changed to 1000Mbps-Full-Duplex
Jan 3 16:02:32 [SYSTEM]: HTTPS, start
Jan 3 16:02:32 [SYSTEM]: HTTP, start
Jan 3 16:02:32 [SYSTEM]: HTTPD, Stopping
Jan 3 16:02:32 [SYSTEM]: SNMP, stop SNMP server
Jan 3 16:02:32 [SYSTEM]: LAN, Firewall Disabled
Jan 3 16:02:32 [SYSTEM]: LAN, NAT Disabled
Jan 3 16:02:32 [SYSTEM]: LAN, stop Firewall
Jan 3 16:02:32 [SYSTEM]: LAN, stop NAT
Jan 3 16:02:32 [SYSTEM]: NET, Firewall Disabled
Jan 3 16:02:32 [SYSTEM]: NET, NAT Disabled
Jan 3 16:02:32 [SYSTEM]: NET, stop Firewall
Jan 3 16:02:32 [SYSTEM]: NET, stop NAT
Jan 3 16:02:30 [SYSTEM]: WLAN[5G], Channel = AutoSelect
Jan 3 16:02:30 [SYSTEM]: WLAN[5G], Wireless Mode = 11ACVHT80
Jan 3 16:02:29 [SYSTEM]: WLAN[2.4G], WSC UPnP start
Jan 3 16:02:26 [SYSTEM]: WLAN[2.4G], Channel = AutoSelect
Jan 3 16:02:26 [SYSTEM]: WLAN[2.4G], CountryRegion = 0
Jan 3 16:02:23 [SYSTEM]: LAN, IP address=192.168.1.230
Jan 3 16:02:23 [SYSTEM]: LAN, start
Jan 3 16:02:23 [SYSTEM]: LAN, Stopping
Jan 3 16:02:22 [SYSTEM]: SYSTEM, Apply settings for [LAN][Radio 24G][Radio 5G][Firewall][Httpd][URL Filter]
Jan 3 00:01:02 [SYSTEM]: WLAN[5G], Best channel selection start, switch to channel 36 + 40 + 44 + 48
Jan 2 00:00:57 [SYSTEM]: WLAN[5G], Best channel selection start, switch to channel 36 + 40 + 44 + 48
Jan 1 00:00:52 [SYSTEM]: WLAN[5G], Best channel selection start, switch to channel 36 + 40 + 44 + 48
Jan 1 00:00:12 [SYSTEM]: LAN, Port[0] link is changed to 1000Mbps-Full-Duplex
Jan 1 00:00:11 [SYSTEM]: HTTPS, start
Jan 1 00:00:11 [SYSTEM]: HTTP, start
Jan 1 00:00:11 [SYSTEM]: LAN, Firewall Disabled
Jan 1 00:00:11 [SYSTEM]: LAN, NAT Disabled
Jan 1 00:00:10 [SYSTEM]: NET, Firewall Disabled
Jan 1 00:00:10 [SYSTEM]: NET, NAT Disabled
Jan 1 00:00:10 [SYSTEM]: LEDs, light on specific LEDs

```

<b>Save</b>	Click to save the log as a file on your local computer.
<b>Clear</b>	Clear all log entries.
<b>Refresh</b>	Refresh the current log.

The following information/events are recorded by the log:

◆ **Wireless Client**

*Connected & disconnected*  
*Key exchange success & fail*

◆ **Authentication**

*Authentication fail or successful.*

◆ **Association**

*Success or fail*

◆ **WPS**

*M1 - M8 messages*

*WPS success*

◆ **Change Settings**

◆ **System Boot**

*Displays current model name*

◆ **NTP Client**

◆ **Wired Link**

*LAN Port link status and speed status*

◆ **Proxy ARP**

*Proxy ARP module start & stop*

◆ **Bridge**

*Bridge start & stop.*

◆ **SNMP**

*SNMP server start & stop.*

◆ **HTTP**

*HTTP start & stop.*

◆ **HTTPS**

*HTTPS start & stop.*

◆ **SSH**

*SSH-client server start & stop.*

◆ **Telnet**

*Telnet-client server start or stop.*

◆ **WLAN (2.4G)**

*WLAN (2.4G] channel status and country/region status*

◆ **WLAN (5G)**

*WLAN (5G) channel status and country/region status*

◆ **ADT**



## 4-2. Network Settings



*Screenshots displayed are examples. The information shown on your screen will vary depending on your configuration.*

### 4-2-1. LAN-Side IP Address

#### • LAN-side IP Address

The “LAN-side IP address” page allows you to configure your access point on your Local Area Network (LAN). You can enable the access point to dynamically receive an IP address from your router’s DHCP server or you can specify a static IP address for your access point, as well as configure DNS servers.



*The access point’s default IP address is 192.168.1.230.*

LAN-side IP Address	
IP Address Assignment	DHCP Client ▾
IP Address	192.168.1.230
Subnet Mask	255.255.255.0
Default Gateway	User-Defined ▾ <input type="text"/>

LAN-side DNS Servers	
Primary Address	User-Defined ▾ <input type="text"/>
Secondary Address	User-Defined ▾ <input type="text"/>

LAN-side IP Address	
<b>IP Address Assignment</b>	Select “DHCP Client” for your access point to be assigned a dynamic IP address from your router’s DHCP server, or select “Static IP” to manually specify a static/fixed IP address for your access point (below).
<b>IP Address</b>	Specify the IP address here. This IP address will be assigned to your access point and will replace the default IP address.

<b>Subnet Mask</b>	Specify a subnet mask. The default value is 255.255.255.0
<b>Default Gateway</b>	For DHCP users, select “From DHCP” to get default gateway from your DHCP server or “User-Defined” to enter a gateway manually. For static IP users, the default value is blank.

DHCP users can select to get DNS servers’ IP address from DHCP or manually enter a value. For static IP users, the default value is blank.

<b>Primary Address</b>	DHCP users can select “From DHCP” to get primary DNS server’s IP address from DHCP or “User-Defined” to manually enter a value. For static IP users, the default value is blank.
<b>Secondary Address</b>	Users can manually enter a value when DNS server’s primary address is set to “User-Defined”.

## 4-2-2. LAN Port

### • LAN Port

The “LAN Port” page allows you to configure the settings for your access point’s two wired LAN (Ethernet) ports.

Wired LAN Port Settings		
Wired LAN Port	Speed & Duplex	802.3az
Wired Port (#1)	Auto ▼	Enabled ▼

<b>Wired LAN Port</b>	Identifies LAN port 1.
<b>Enable</b>	Enable/disable LAN port.
<b>Speed &amp; Duplex</b>	Select a speed & duplex type for LAN port, or use the “Auto” value. LAN ports can operate up to 1000Mbps and full-duplex enables simultaneous data packets transfer/receive.
<b>Flow Control</b>	Enable/disable flow control. Flow control can pause new session request until current data processing is complete, in order to avoid device overloads under heavy traffic.
<b>802.3az</b>	Enable/disable 802.3az. 802.3az is an Energy Efficient Ethernet feature which disables unused interfaces to reduce power usage.

### 4-2-3. VLAN

#### VLAN

The “VLAN” (Virtual Local Area Network) enables you to configure VLAN settings. A VLAN is a local area network which maps workstations virtually instead of physically and allows you to group together or isolate users from each other. VLAN IDs 1 – 4094 are supported.



***VLAN IDs in the range 1 – 4094 are supported.***

VLAN Interface		
Wired LAN Port	VLAN Mode	VLAN ID
Wired Port (#1)	Untagged Port ▼	1
Wireless 2.4GHz	VLAN Mode	VLAN ID
SSID [HW12ACM_2.4]	Untagged Port	1
Wireless 5GHz	VLAN Mode	VLAN ID
SSID [HW12ACM_5]	Untagged Port	1

Management VLAN	
VLAN ID	1

VLAN Interface	
<b>Wired LAN Port/Wireless</b>	Identifies LAN port 1 and wireless SSIDs (2.4GHz or 5GHz).
<b>VLAN Mode</b>	Select “Tagged Port” or “Untagged Port” for LAN interface.
<b>VLAN ID</b>	Set a VLAN ID for specified interface, if “Untagged Port” is selected.

Management VLAN	
<b>VLAN ID</b>	Specify the VLAN ID of the management VLAN. Only the hosts belonging to the same VLAN can manage the device.

## 4-3. Wireless Settings



*Screenshots displayed are examples. The information shown on your screen will vary depending on your configuration.*

### 4-3-1. 2.4GHz 11bgn

- **2.4GHz 11bgn** The “2.4GHz 11bgn” menu allows you to view and configure information for your access point’s 2.4GHz wireless network across four categories: Basic, Advanced, Security and WDS.

### 4-3-1-1. Basic

#### Basic

The “Basic” screen displays basic settings for your access point’s 2.4GHz Wi-Fi network (s).

2.4GHz Basic Settings	
Wireless	<input checked="" type="radio"/> Enable <input type="radio"/> Disable
Band	11b/g/n ▾
Enable SSID number	1 ▾
SSID1	HOW17ACM_2.4GHz <input type="text"/> VLAN ID <input type="text" value="1"/>
Auto Channel	<input type="radio"/> Enable <input checked="" type="radio"/> Disable
Channel	Ch 11, 2462MHz ▾
Channel Bandwidth	Auto, +Ch 7 ▾
BSS BasicRate Set	1,2,5.5,11 Mbps ▾

<b>Wireless</b>	Enable or disable the access point's 2.4GHz wireless radio. When disabled, no 2.4GHz SSIDs will be active.
<b>Band</b>	Select the wireless standard used for the access point. Combinations of 802.11b, 802.11g & 802.11n can be selected.
<b>Enable SSID Number</b>	Select how many SSIDs to enable for the 2.4GHz frequency from the drop down menu. A maximum of 16 can be enabled.
<b>SSID#</b>	Enter the SSID name for the specified SSID (up to 16). The SSID can consist of any combination of up to 32 alphanumeric characters.
<b>VLAN ID</b>	Specify a VLAN ID for each SSID.
<b>Auto Channel</b>	Enable/disable auto channel selection. Auto channel selection will automatically set the wireless channel for the access point's 2.4GHz frequency based on availability and potential interference. When disabled, select a channel manually as shown in the next table.
<b>Auto Channel Range</b>	Select a range from which the auto channel setting (above) will choose a channel.
<b>Auto Channel Interval</b>	Specify a frequency for how often the auto channel setting will check/reassign the wireless channel. Check/uncheck the "Change channel even if clients are connected" box according to your preference.
<b>Channel Bandwidth</b>	Set the channel bandwidth: 20MHz (lower performance but less interference), 40MHz (higher performance but potentially higher interference) or Auto (automatically select based on interference level).
<b>BSS BasicRateSet</b>	Set a Basic Service Set (BSS) rate: this is a series of rates to control communication frames for wireless clients.

When auto channel is disabled, select a wireless channel manually:

<b>Auto Channel</b>	<input type="radio"/> Enable <input checked="" type="radio"/> Disable
<b>Channel</b>	Ch 11, 2462MHz ▼
<b>Channel Bandwidth</b>	Auto, +Ch 7 ▼
<b>BSS BasicRateSet</b>	1,2,5.5,11 Mbps ▼

<b>Channel</b>	Select a wireless channel from 1 – 11.
<b>Channel Bandwidth</b>	Set the channel bandwidth: 20MHz (lower performance but less interference), 40MHz (higher performance but potentially higher interference) or Auto (automatically select based on interference level).
<b>BSS BasicRate Set</b>	Set a Basic Service Set (BSS) rate: this is a series of rates to control communication frames for wireless clients.



#### 4-3-1-2. Advanced

##### Advanced

These settings are for experienced users only. Please do not change any of the values on this page unless you are already familiar with these functions.



**Changing these settings can adversely affect the performance of your access point.**

2.4GHz Advanced Settings	
Contention Slot	Short ▼
Preamble Type	Short ▼
Guard Interval	Short GI ▼
802.11g Protection	<input checked="" type="radio"/> Enable <input type="radio"/> Disable
802.11n Protection	<input checked="" type="radio"/> Enable <input type="radio"/> Disable
DTIM Period	1 (1-255)
RTS Threshold	2347 (1-2347)
Fragment Threshold	2346 (256-2346)
Multicast Rate	Auto ▼
Tx Power	100% ▼
Beacon Interval	100 (40-1000 ms)
Station idle timeout	60 (30-65535 seconds)

<b>Contention Slot</b>	Select “Short” or “Long” – this value is used for contention windows in WMM (see <b>4-3-6. WMM</b> ).
<b>Preamble Type</b>	Set the wireless radio preamble type. The preamble type in 802.11 based wireless communication defines the length of the CRC (Cyclic Redundancy Check) block for communication between the access point and roaming wireless adapters. The default value is “Short Preamble”.
<b>Guard Interval</b>	Set the guard interval. A shorter interval can improve performance.
<b>802.11g Protection</b>	Enable/disable 802.11g protection, which increases reliability but reduces bandwidth (clients will send Request to Send (RTS) to access point, and access point will broadcast Clear to Send (CTS), before a packet is sent from client.)

<b>802.11n Protection</b>	Enable/disable 802.11n protection, which increases reliability but reduces bandwidth (clients will send Request to Send (RTS) to access point, and access point will broadcast Clear to Send (CTS), before a packet is sent from client.)
<b>DTIM Period</b>	Set the DTIM (delivery traffic indication message) period value of the wireless radio. The default value is 1.
<b>RTS Threshold</b>	Set the RTS threshold of the wireless radio. The default value is 2347.
<b>Fragment Threshold</b>	Set the fragment threshold of the wireless radio. The default value is 2346.
<b>Multicast Rate</b>	Set the transfer rate for multicast packets or use the "Auto" setting.
<b>Tx Power</b>	Set the power output of the wireless radio. You may not require 100% output power. Setting a lower power output can enhance security since potentially malicious/unknown users in distant areas will not be able to access your signal.
<b>Beacon Interval</b>	Set the beacon interval of the wireless radio. The default value is 100.
<b>Station idle timeout</b>	Set the interval for keepalive messages from the access point to a wireless client to verify if the station is still alive/active.

### 4-3-1-3. Security

#### • Security

The access point provides various security options (wireless data encryption). When data is encrypted, information transmitted wirelessly cannot be read by anyone who does not know the correct encryption key.



***It's essential to configure wireless security in order to prevent unauthorised access to your network.***



***Select hard-to-guess passwords which include combinations of numbers, letters and symbols, and change your password regularly.***

2.4GHz Wireless Security Settings	
SSID	HOW17ACM_2.4GHz ▾
Broadcast SSID	Enable ▾
Wireless Client Isolation	Disable ▾
Load Balancing	50 /50
Authentication Method	No Authentication ▾
Additional Authentication	No additional authentication ▾

Apply

Cancel

<b>SSID Selection</b>	Select which SSID to configure security settings for.
<b>Broadcast SSID</b>	Enable or disable SSID broadcast. When enabled, the SSID will be visible to clients as an available Wi-Fi network. When disabled, the SSID will not be visible as an available Wi-Fi network to clients – clients must manually enter the SSID in order to connect. A hidden (disabled) SSID is typically more secure than a visible (enabled) SSID.
<b>Wireless Client Isolation</b>	Enable or disable wireless client isolation. Wireless client isolation prevents clients connected to the access point from communicating with each other and improves security. Typically, this function is useful for corporate environments or public hot spots and can prevent brute force attacks on clients' usernames and passwords.
<b>Load Balancing</b>	Load balancing limits the number of wireless clients connected to an SSID. Set a load balancing value (maximum 50).
<b>Authentication Method</b>	Select an authentication method from the drop down menu and refer to the information below appropriate for your method.
<b>Additional Authentication</b>	Select an additional authentication method from the drop down menu and refer to the information below (4-3-1-3-6.) appropriate for your method.

#### 4-3-1-3-1. No Authentication

Authentication is disabled and no password/key is required to connect to the access point.



***Disabling wireless authentication is not recommended. When disabled, anybody within range can connect to your device's SSID.***

#### 4-3-1-3-2. WEP

WEP (Wired Equivalent Privacy) is a basic encryption type. For a higher level of security consider using WPA encryption.

<b>Key Length</b>	Select 64-bit or 128-bit. 128-bit is more secure than 64-bit and is recommended.
<b>Key Type</b>	Choose from "ASCII" (any alphanumeric character 0-9, a-z and A-Z) or "Hex" (any characters from 0-9, a-f and A-F).
<b>Default Key</b>	Select which encryption key (1 – 4 below) is the default key. For security purposes, you can set up to four keys (below) and change which is the default key.
<b>Encryption Key 1 – 4</b>	Enter your encryption key/password according to the format you selected above.

#### 4-3-1-3-3. IEEE802.1x/EAP

<b>Key Length</b>	Select 64-bit or 128-bit. 128-bit is more secure than 64-bit and is recommended.
-------------------	--

#### 4-3-1-3-4. WPA-PSK

WPA-PSK is a secure wireless encryption type with strong data protection and user authentication, utilizing 128-bit encryption keys.

<b>WPA Type</b>	Select from WPA/WPA2 Mixed Mode-PSK, WPA2 or WPA only. WPA2 is safer than WPA only, but not supported by all wireless clients. Please make sure your wireless client supports your selection.
<b>Encryption</b>	Select "TKIP/AES Mixed Mode" or "AES" encryption type.
<b>Key Renewal Interval</b>	Specify a frequency for key renewal in minutes.
<b>Pre-Shared Key Type</b>	Choose from "Passphrase" (8 – 63 alphanumeric characters) or "Hex" (up to 64 characters from 0-9, a-f and A-F).
<b>Pre-Shared Key</b>	Please enter a security key/password according to the format you selected above.

#### 4-3-1-3-5. WPA-EAP

<b>WPA Type</b>	Select from WPA/WPA2 Mixed Mode-EAP, WPA2-EAP or WPA-EAP.
<b>Encryption</b>	Select “TKIP/AES Mixed Mode” or “AES” encryption type.
<b>Key Renewal Interval</b>	Specify a frequency for key renewal in minutes.



**WPA-EAP must be disabled to use MAC-RADIUS authentication.**

#### 4-3-1-3-6. Additional Authentication

Additional wireless authentication methods can also be used:

#### MAC Address Filter

Restrict wireless clients access based on MAC address specified in the MAC filter table.



**See 4-3-5. MAC Filter to configure MAC filtering.**

#### MAC Filter & MAC-RADIUS Authentication

Restrict wireless clients access using both of the above MAC filtering & RADIUS authentication methods.

#### MAC-RADIUS Authentication

Restrict wireless clients access based on MAC address via a RADIUS server, or password authentication via a RADIUS server.



**See 4-3-4. RADIUS to configure RADIUS servers.**



**WPS must be disabled to use MAC-RADIUS authentication. See 4-3-3. for WPS settings.**

MAC RADIUS Password

Use MAC address  
 Use the following password

<b>MAC RADIUS Password</b>	Select whether to use MAC address or password authentication via RADIUS server. If you select “Use the following password”, enter the password in the field below. The password should match the “Shared Secret” used in <b>4-3-4. RADIUS.</b>
----------------------------	--



#### 4-3-1-4. WDS

##### • WDS

Wireless Distribution System (WDS) can bridge/repeat access points together in an extended network. WDS settings can be configured as shown below.



**When using WDS, configure the IP address of each access point to be in the same subnet and ensure there is only one active DHCP server among connected access points, preferably on the WAN side.**

WDS must be configured on each access point, using correct MAC addresses. All access points should use the same wireless channel and encryption method.

2.4GHz	
WDS Functionality	Disabled ▾
Local MAC Address	74:DA:38:0B:04:B2

WDS Peer Settings	
WDS #1	MAC Address <input type="text"/>
WDS #2	MAC Address <input type="text"/>
WDS #3	MAC Address <input type="text"/>
WDS #4	MAC Address <input type="text"/>

WDS VLAN	
VLAN Mode	Untagged Port ▾ (Enter at least one MAC address.)
VLAN ID	1 <input type="text"/>

WDS Encryption method	
Encryption	None ▾ (Enter at least one MAC address.)

Apply Reset



2.4GHz	
WDS Functionality	Select "WDS with AP" to use WDS with access point or "Dedicated WDS" to use WDS and also block communication with regular wireless clients. When WDS is used, each access point should be configured with corresponding MAC addresses, wireless channel and wireless encryption method.
Local MAC Address	Displays the MAC address of your access point.

WDS Peer Settings	
WDS #	Enter the MAC address for up to four other WDS devices you wish to connect.

WDS VLAN	
VLAN Mode	Specify the WDS VLAN mode to "Untagged Port" or "Tagged Port".
VLAN ID	Specify the WDS VLAN ID when "Untagged Port" is selected above.

WDS Encryption method	
Encryption	Select whether to use "None" or "AES" encryption and enter a pre-shared key for AES consisting of 8-63 alphanumeric characters.

## 4-3-2. 5GHz 11ac 11an

- **5GHz 11ac 11an**

The “5GHz 11ac 11an” menu allows you to view and configure information for your access point’s 5GHz wireless network across four categories: Basic, Advanced, Security and WDS.

### 4-3-2-1. Basic

- **Basic**

The “Basic” screen displays basic settings for your access point’s 5GHz Wi-Fi network (s).

5GHz Basic Settings	
Wireless	<input checked="" type="radio"/> Enable <input type="radio"/> Disable
Band	11a/n/ac ▾
Enable SSID number	1 ▾
SSID1	HOW17ACM_5GHz <input type="text"/> VLAN ID <input type="text" value="1"/>
Auto Channel	<input checked="" type="radio"/> Enable <input type="radio"/> Disable
Auto Channel Range	Band 1 ▾
Auto Channel Interval	One day ▾ <input type="checkbox"/> Change channel even if clients are connected
Channel Bandwidth	Auto 80/40/20 MHz ▾
BSS BasicRateSet	6,12,24 Mbps ▾

<b>Wireless</b>	Enable or disable the access point’s 5GHz wireless radio. When disabled, no 5GHz SSIDs will be active.
<b>Band</b>	Select the wireless standard used for the access point. Combinations of 802.11a, 802.11n & 802.11ac can be selected.
<b>Enable SSID Number</b>	Select how many SSIDs to enable for the 5GHz frequency from the drop down menu. A maximum of 16 can be enabled.
<b>SSID#</b>	Enter the SSID name for the specified SSID (up to 16). The SSID can consist of any combination of up to 32 alphanumeric characters.

<b>VLAN ID</b>	Specify a VLAN ID for each SSID.
<b>Auto Channel</b>	Enable/disable auto channel selection. Auto channel selection will automatically set the wireless channel for the access point's 5GHz frequency based on availability and potential interference. When disabled, select a channel manually as shown in the next table.
<b>Auto Channel Range</b>	Select a range from which the auto channel setting (above) will choose a channel.
<b>Auto Channel Interval</b>	Specify a frequency for how often the auto channel setting will check/reassign the wireless channel. Check/uncheck the "Change channel even if clients are connected" box according to your preference.
<b>Channel Bandwidth</b>	Set the channel bandwidth: 20MHz (lower performance but less interference), Auto 40/20MHz or Auto 80/40/20MHz (automatically select based on interference level).
<b>BSS BasicRate Set</b>	Set a Basic Service Set (BSS) rate: this is a series of rates to control communication frames for wireless clients.

When auto channel is disabled, select a wireless channel manually:

<b>Auto Channel</b>	<input type="radio"/> Enable <input checked="" type="radio"/> Disable
<b>Channel</b>	Ch 36, 5.18GHz ▼
<b>Channel Bandwidth</b>	Auto 80/40/20 MHz ▼
<b>BSS BasicRate Set</b>	6,12,24 Mbps ▼

<b>Channel</b>	Select a wireless channel.
<b>Channel Bandwidth</b>	Set the channel bandwidth: 20MHz (lower performance but less interference), Auto 40/20MHz or Auto 80/40/20MHz (automatically select based on interference level).
<b>BSS BasicRate Set</b>	Set a Basic Service Set (BSS) rate: this is a series of rates to control communication frames for wireless clients.

#### 4-3-2-2. Advanced

##### Advanced

These settings are for experienced users only. Please do not change any of the values on this page unless you are already familiar with these functions.



***Changing these settings can adversely affect the performance of your access point.***

## 5GHz Advanced Settings

Guard Interval	Short GI ▼
802.11n Protection	<input checked="" type="radio"/> Enable <input type="radio"/> Disable
DTIM Period	1 (1-255)
RTS Threshold	2347 (1-2347)
Fragment Threshold	2346 (256-2346)
Multicast Rate	Auto ▼
Tx Power	100% ▼
Beacon Interval	100 (40-1000 ms)
Station idle timeout	60 (30-65535 seconds)

<b>Guard Interval</b>	Set the guard interval. A shorter interval can improve performance.
<b>802.11n Protection</b>	Enable/disable 802.11n protection, which increases reliability but reduces bandwidth (clients will send Request to Send (RTS) to access point, and access point will broadcast Clear to Send (CTS), before a packet is sent from client.)
<b>DTIM Period</b>	Set the DTIM (delivery traffic indication message) period value of the wireless radio. The default value is 1.
<b>RTS Threshold</b>	Set the RTS threshold of the wireless radio. The default value is 2347.
<b>Fragment Threshold</b>	Set the fragment threshold of the wireless radio. The default value is 2346.
<b>Multicast Rate</b>	Set the transfer rate for multicast packets or use the “Auto” setting.
<b>Tx Power</b>	Set the power output of the wireless radio. You may not require 100% output power. Setting a lower power output can enhance security since potentially malicious/unknown users in distant areas will not be able to access your signal.
<b>Beacon Interval</b>	Set the beacon interval of the wireless radio. The default value is 100.
<b>Station idle timeout</b>	Set the interval for keepalive messages from the access point to a wireless client to verify if the station is still alive/active.

### 4-3-2-3. Security

#### Security

The access point provides various security options (wireless data encryption). When data is encrypted, information transmitted wirelessly cannot be read by anyone who does not know the correct encryption key.



***It's essential to configure wireless security in order to prevent unauthorised access to your network.***



***Select hard-to-guess passwords which include combinations of numbers, letters and symbols, and change your password regularly.***

5GHz Wireless Security Settings	
SSID	HOW17ACM_5GHz ▾
Broadcast SSID	Enable ▾
Wireless Client Isolation	Disable ▾
Load Balancing	50 /50
Authentication Method	No Authentication ▾
Additional Authentication	No additional authentication ▾

<b>SSID Selection</b>	Select which SSID to configure security settings for.
<b>Broadcast SSID</b>	Enable or disable SSID broadcast. When enabled, the SSID will be visible to clients as an available Wi-Fi network. When disabled, the SSID will not be visible as an available Wi-Fi network to clients – clients must manually enter the SSID in order to connect. A hidden (disabled) SSID is typically more secure than a visible (enabled) SSID.
<b>Wireless Client Isolation</b>	Enable or disable wireless client isolation. Wireless client isolation prevents clients connected to the access point from communicating with each other and improves security. Typically, this function is useful for corporate environments or public hot spots and can prevent brute force attacks on clients' usernames and passwords.

<b>Load Balancing</b>	Load balancing limits the number of wireless clients connected to an SSID. Set a load balancing value (maximum 50).
<b>Authentication Method</b>	Select an authentication method from the drop down menu and refer to the information below appropriate for your method.
<b>Additional Authentication</b>	Select an additional authentication method from the drop down menu and refer to the information below appropriate for your method.

Please refer back to **4-3-1-3. Security** for more information on authentication and additional authentication types.

#### 4-3-2-4. WDS

##### • WDS

Wireless Distribution System (WDS) can bridge/repeat access points together in an extended network. WDS settings can be configured as shown below.



**When using WDS, configure the IP address of each access point to be in the same subnet and ensure there is only one active DHCP server among connected access points, preferably on the WAN side.**

WDS must be configured on each access point, using correct MAC addresses. All access points should use the same wireless channel and encryption method.

5GHz WDS Mode	
WDS Functionality	Disabled <input type="button" value="v"/>
Local MAC Address	74:DA:38:0B:04:B3

WDS Peer Settings	
WDS #1	MAC Address <input type="text"/>
WDS #2	MAC Address <input type="text"/>
WDS #3	MAC Address <input type="text"/>
WDS #4	MAC Address <input type="text"/>

WDS VLAN	
VLAN Mode	Untagged Port <input type="button" value="v"/> (Enter at least one MAC address.)
VLAN ID	1 <input type="text"/>

Encryption method	
Encryption	None <input type="button" value="v"/> (Enter at least one MAC address.)

5GHz WDS Mode

WDS Functionality	Select “WDS with AP” to use WDS with access point or “Dedicated WDS” to use WDS and also block communication with regular wireless clients. When WDS is used, each access point should be configured with corresponding MAC addresses, wireless channel and wireless encryption method.
Local MAC Address	Displays the MAC address of your access point.

WDS Peer Settings	
WDS #	Enter the MAC address for up to four other WDA devices you wish to connect.

WDS VLAN	
VLAN Mode	Specify the WDS VLAN mode to “Untagged Port” or “Tagged Port”.
VLAN ID	Specify the WDS VLAN ID when “Untagged Port” is selected above.

WDS Encryption	
Encryption	Select whether to use “None” or “AES” encryption and enter a pre-shared key for AES with 8-63 alphanumeric characters.

### 4-3-3. WPS

#### • WPS

Wi-Fi Protected Setup is a simple way to establish connections between WPS compatible devices. WPS can be activated on compatible devices by pushing a WPS button on the device or from within the device’s firmware/configuration interface (known as PBC or “Push Button Configuration”). When WPS is activated in the correct manner and at the correct time for two compatible devices, they will automatically connect. “PIN code WPS” is a variation of PBC which includes the additional use of a PIN code between the two devices for verification.



***Please refer to manufacturer’s instructions for your other WPS device.***



WPS	<input checked="" type="checkbox"/> Enable
-----	--

Apply

WPS	
Product PIN	07220982 <input type="button" value="Generate PIN"/>
Push-button WPS	<input type="button" value="Start"/>
WPS by PIN	<input type="text"/> <input type="button" value="Start"/>

WPS Security	
WPS Status	Configured <input type="button" value="Release"/>

<b>WPS</b>	Check/uncheck this box to enable/disable WPS functionality. WPS must be disabled when using MAC-RADIUS authentication (see <b>4-3-1-3-6 &amp; 4-3-4</b> ).
------------	--

<b>Product PIN</b>	Displays the WPS PIN code of the device, used for PIN code WPS. You will be required to enter this PIN code into another WPS device for PIN code WPS. Click “Generate PIN” to generate a new WPS PIN code.
<b>Push-Button WPS</b>	Click “Start” to activate WPS on the access point for approximately 2 minutes. This has the same effect as physically pushing the access point’s WPS button.
<b>WPS by PIN</b>	Enter the PIN code of another WPS device and click “Start” to attempt to establish a WPS connection for approximately 2 minutes.

<b>WPS Status</b>	WPS security status is displayed here. Click “Release” to clear the existing status.
-------------------	--

#### 4-3-4. RADIUS

##### RADIUS

The RADIUS sub menu allows you to configure the access point's RADIUS server settings, categorized into three submenus: RADIUS settings, Internal Server and RADIUS accounts.

A RADIUS server provides user-based authentication to improve security and offer wireless client control – users can be authenticated before gaining access to a network.

The access point can utilize both a primary and secondary (backup) RADIUS server for each of its wireless frequencies (2.4GHz & 5GHz). External RADIUS servers can be used or the access point's internal RADIUS server can be used.



**To use RADIUS servers, go to “Wireless Settings” → “Security” and select “MAC RADIUS Authentication” → “Additional Authentication” and select “MAC RADIUS Authentication” (see 4-3-1-3. & 4-3-2-3).**

#### RADIUS Settings

Configure the RADIUS server settings for 2.4GHz & 5GHz. Each frequency can use an internal or external RADIUS server.

RADIUS Server (2.4GHz)	
<b>Primary RADIUS Server</b>	
RADIUS Server	<input type="text"/>
Authentication Port	<input type="text" value="1812"/>
Shared Secret	<input type="text"/>
Session Timeout	<input type="text" value="3600"/> second(s)
Accounting	<input checked="" type="radio"/> Enable <input type="radio"/> Disable
Accounting Port	<input type="text" value="1813"/>
<b>Secondary RADIUS Server</b>	
RADIUS Server	<input type="text"/>
Authentication Port	<input type="text" value="1812"/>
Shared Secret	<input type="text"/>
Session Timeout	<input type="text" value="3600"/> second(s)
Accounting	<input checked="" type="radio"/> Enable <input type="radio"/> Disable
Accounting Port	<input type="text" value="1813"/>

## RADIUS Server (5GHz)

Primary RADIUS Server	
RADIUS Server	<input type="text"/>
Authentication Port	<input type="text" value="1812"/>
Shared Secret	<input type="text"/>
Session Timeout	<input type="text" value="3600"/> second(s)
Accounting	<input checked="" type="radio"/> Enable <input type="radio"/> Disable
Accounting Port	<input type="text" value="1813"/>

Secondary RADIUS Server	
RADIUS Server	<input type="text"/>
Authentication Port	<input type="text" value="1812"/>
Shared Secret	<input type="text"/>
Session Timeout	<input type="text" value="3600"/> second(s)
Accounting	<input checked="" type="radio"/> Enable <input type="radio"/> Disable
Accounting Port	<input type="text" value="1813"/>

<b>RADIUS Type</b>	Select "Internal" to use the access point's built-in RADIUS server or "external" to use an external RADIUS server.
<b>RADIUS Server</b>	Enter the RADIUS server host IP address.
<b>Authentication Port</b>	Set the UDP port used in the authentication protocol of the RADIUS server. Value must be between 1 – 65535.
<b>Shared Secret</b>	Enter a shared secret/password between 1 – 99 characters in length. This should match the "MAC-RADIUS" password used in <b>4-3-1-3-6</b> or <b>4-3-2-3</b> .
<b>Session Timeout</b>	Set a duration of session timeout in seconds between 0 – 86400.
<b>Accounting</b>	Enable or disable RADIUS accounting.
<b>Accounting Port</b>	When accounting is enabled (above), set the UDP port used in the accounting protocol of the RADIUS server. Value must be between 1 – 65535.

### 4-3-5. MAC Filter

#### • MAC Filter

Mac filtering is a security feature that can help to prevent unauthorized users from connecting to your access point.

This function allows you to define a list of network devices permitted to connect to the access point. Devices are each identified by their unique MAC address. If a device which is not on the list of permitted MAC addresses attempts to connect to the access point, it will be denied.



**To enable MAC filtering, go to “Wireless Settings” → “2.4GHz 11bgn/5GHz 11ac 11an” → “Security” → “Additional Authentication” and select “MAC Filter” (see 4-3-1-3. & 4-3-2-3).**

The MAC address filtering table is displayed below:

#### Add MAC Addresses

AddReset

#### MAC Address Filtering Table

Select	MAC Address
No MAC Address entries.	

Delete Selected Delete All Export

<b>Add MAC Address</b>	Enter a MAC address of computer or network device manually e.g. 'aa-bb-cc-dd-ee-ff' or enter multiple MAC addresses
------------------------	---

	separated with commas, e.g. 'aa-bb-cc-dd-ee-ff,aa-bb-cc-dd-ee-gg'
<b>Add</b>	Click "Add" to add the MAC address to the MAC address filtering table.
<b>Reset</b>	Clear all fields.

MAC address entries will be listed in the "MAC Address Filtering Table". Select an entry using the "Select" checkbox.

<b>Select</b>	Delete selected or all entries from the table.
<b>MAC Address</b>	The MAC address is listed here.
<b>Delete Selected</b>	Delete the selected MAC address from the list.
<b>Delete All</b>	Delete all entries from the MAC address filtering table.
<b>Export</b>	Click "Export" to save a copy of the MAC filtering table. A new window will pop up for you to select a location to save the file.

#### 4-3-6. WMM

##### • WMM

Wi-Fi Multimedia (WMM) is a Wi-Fi Alliance interoperability certification based on the IEEE 802.11e standard, which provides Quality of Service (QoS) features to IEEE 802.11 networks. WMM prioritizes traffic according to four categories: background, best effort, video and voice.

**WMM-EDCA Settings**

WMM Parameters of Access Point				
	CWMin	CWMax	AIFSN	TxOP
<b>Back Ground</b>	<input type="text" value="4"/>	<input type="text" value="10"/>	<input type="text" value="7"/>	<input type="text" value="0"/>
<b>Best Effort</b>	<input type="text" value="4"/>	<input type="text" value="6"/>	<input type="text" value="3"/>	<input type="text" value="0"/>
<b>Video</b>	<input type="text" value="3"/>	<input type="text" value="4"/>	<input type="text" value="1"/>	<input type="text" value="94"/>
<b>Voice</b>	<input type="text" value="2"/>	<input type="text" value="3"/>	<input type="text" value="1"/>	<input type="text" value="47"/>

WMM Parameters of Station				
	CWMin	CWMax	AIFSN	TxOP
<b>Back Ground</b>	<input type="text" value="4"/>	<input type="text" value="10"/>	<input type="text" value="7"/>	<input type="text" value="0"/>
<b>Best Effort</b>	<input type="text" value="4"/>	<input type="text" value="10"/>	<input type="text" value="3"/>	<input type="text" value="0"/>
<b>Video</b>	<input type="text" value="3"/>	<input type="text" value="4"/>	<input type="text" value="2"/>	<input type="text" value="94"/>
<b>Voice</b>	<input type="text" value="2"/>	<input type="text" value="3"/>	<input type="text" value="2"/>	<input type="text" value="47"/>

Configuring WMM consists of adjusting parameters on queues for different categories of wireless traffic. Traffic is sent to the following queues:

<b>Background</b>	Low Priority	High throughput, non time sensitive bulk data e.g. FTP
<b>Best Effort</b>	Medium Priority	Traditional IP data, medium throughput and delay.
<b>Video</b>	High Priority	Time sensitive video data with minimum time delay.
<b>Voice</b>	High Priority	Time sensitive data such as VoIP and streaming media with minimum time delay.

Queues automatically provide minimum transmission delays for video, voice, multimedia and critical applications. The values can further be adjusted manually:

<b>CWMin</b>	Minimum Contention Window (milliseconds): This value is input to the initial random backoff wait time algorithm for retry of a data frame transmission. The backoff wait time will be generated between 0 and this value. If the frame is not sent, the random backoff value is doubled until the value reaches the number defined by CWMax (below). The CWMin value must be lower than the CWMax value. The contention window scheme helps to avoid frame collisions and determine priority of frame transmission. A shorter window has a higher probability (priority) of transmission.
<b>CWMax</b>	Maximum Contention Window (milliseconds): This value is the upper limit to random backoff value doubling (see above).
<b>AIFSN</b>	Arbitration Inter-Frame Space (milliseconds): Specifies additional time between when a channel goes idle and the AP/client sends data frames. Traffic with a lower AIFSN value has a higher priority.
<b>TxOP</b>	Transmission Opportunity (milliseconds): The maximum interval of time an AP/client can transmit. This makes channel access more efficiently prioritized. A value of 0 means only one frame per transmission. A greater value effects higher priority.

## 4-4. Management



*Screenshots displayed are examples. The information shown on your screen will vary depending on your configuration.*

### 4-4-1. Admin

#### • Admin

You can change the password used to login to the browser-based configuration interface here. It is advised to do so for security purposes.



*If you change the administrator password, please make a note of the new password. In the event that you forget this password and are unable to login to the browser based configuration interface, see Chapter 1-5 for how to reset the access point.*



Account to Manage This Device	
Administrator Name	<input type="text" value="admin"/>
Administrator Password	<input type="password" value="•••••"/> (4-32Characters)
	<input type="password" value="•••••"/> (Confirm)
<input type="button" value="Apply"/>	

Advanced Settings	
Product Name	<input type="text" value="HOW17ACM"/>
Management Protocol	<input checked="" type="checkbox"/> HTTP <input checked="" type="checkbox"/> HTTPS <input type="checkbox"/> TELNET <input type="checkbox"/> SSH <input type="checkbox"/> SNMP
SNMP Version	<input type="text" value="v1/v2c"/> ▾
SNMP Get Community	<input type="text" value="public"/>
SNMP Set Community	<input type="text" value="private"/>
SNMP Trap	<input type="text" value="Disabled"/> ▾
SNMP Trap Community	<input type="text" value="public"/>
SNMP Trap Manager	<input type="text"/>
<input type="button" value="Apply"/>	

Account to Manage This Device	
<b>Administrator Name</b>	Set the access point's administrator name. This is used to log in to the browser based configuration interface and must be between 4-16 alphanumeric characters (case sensitive).
<b>Administrator Password</b>	Set the access point's administrator password. This is used to log in to the browser based configuration interface and must be between 4-32 alphanumeric characters (case sensitive).

Advanced Settings	
<b>Product Name</b>	Edit the product name according to your preference consisting of 1-32 alphanumeric characters. This name is used for reference purposes.

<b>Management Protocol</b>	Check/uncheck the boxes to enable/disable specified management interfaces (see below). When SNMP is enabled, complete the SNMP fields below.
<b>SNMP Version</b>	Select SNMP version appropriate for your SNMP manager.
<b>SNMP Get Community</b>	Enter an SNMP Get Community name for verification with the SNMP manager for SNMP-GET requests.
<b>SNMP Set Community</b>	Enter an SNMP Set Community name for verification with the SNMP manager for SNMP-SET requests.
<b>SNMP Trap</b>	Enable or disable SNMP Trap to notify SNMP manager of network errors.
<b>SNMP Trap Community</b>	Enter an SNMP Trap Community name for verification with the SNMP manager for SNMP-TRAP requests.
<b>SNMP Trap Manager</b>	Specify the IP address or sever name (2-128 alphanumeric characters) of the SNMP manager.

#### **HTTP**

*Internet browser HTTP protocol management interface*

#### **HTTPS**

*Internet browser HTTPS protocol management interface*

#### **TELNET**

*Client terminal with telnet protocol management interface*

#### **SSH**

*Client terminal with SSH protocol version 1 or 2 management interface*

#### **SNMP**

*Simple Network Management Protocol. SNMPv1, v2 & v3 protocol supported. SNMPv2 can be used with community based authentication. SNMPv3 uses user-based security model (USM) architecture.*

## 4-4-2. Date and Time

### • Date and Time

You can configure the time zone settings of your access point here. The date and time of the device can be configured manually or can be synchronized with a time server.

**Date and Time Settings**

<b>Local Time</b>	<div style="display: flex; justify-content: space-between;"> <span>2012 <small>Year</small></span> <span>Jan <small>Month</small></span> <span>1 <small>Day</small></span> </div> <div style="display: flex; justify-content: space-between; margin-top: 5px;"> <span>0 <small>Hours</small></span> <span>00 <small>Minutes</small></span> <span>00 <small>Seconds</small></span> </div>
<input type="button" value="Acquire Current Time from Your PC"/>	

**NTP Time Server**

<b>Use NTP</b>	<input type="checkbox"/> Enable
<b>Server Name</b>	<input style="width: 100%;" type="text"/>
<b>Update Interval</b>	24 (Hours)

**Time Zone**

<b>Time Zone</b>	<input style="width: 100%;" type="text" value="(GMT-06:00) Central Time (US &amp; Canada)"/>
------------------	--

Date and Time Settings	
<b>Local Time</b>	Set the access point's date and time manually using the drop down menus.
<b>Acquire Current Time from your PC</b>	Click "Acquire Current Time from Your PC" to enter the required values automatically according to your computer's current time and date.

NTP Time Server	
<b>Use NTP</b>	The access point also supports NTP (Network Time Protocol) for automatic time and date setup.
<b>Server Name</b>	Enter the host name or IP address of the time server if you wish.
<b>Update Interval</b>	Specify a frequency (in hours) for the access point to update/synchronize with the NTP server.

Time Zone	
<b>Time Zone</b>	Select the time zone of your country/ region. If your country/region is not listed, please select another country/region whose time zone is the same as yours.

### 4-4-3. Syslog Server

#### • Syslog Server

The system log can be sent to a server.

Syslog Server Settings	
Transfer Logs	<input type="checkbox"/> Enable Syslog Server <input type="text"/>

<b>Transfer Logs</b>	Check/uncheck the box to enable/disable the use of a syslog server, and enter a host name, domain or IP address for the server, consisting of up to 128 alphanumeric characters.
----------------------	--

#### 4-4-4. I'm Here

##### I'm Here

The access point features a built-in buzzer which can sound on command using the "I'm Here" page. This is useful for network administrators and engineers working in complex network environments to locate the access point.

**Duration of Sound**

Duration of Sound	<input type="text" value="10"/>	(1-300 seconds)
-------------------	---------------------------------	-----------------



***The buzzer is loud!***

<b>Duration of Sound</b>	Set the duration for which the buzzer will sound when the "Sound Buzzer" button is clicked.
<b>Sound Buzzer</b>	Activate the buzzer sound for the above specified duration of time.

## 4-5. Advanced



*Screenshots displayed are examples. The information shown on your screen will vary depending on your configuration.*

### 4-5-1. LED Settings

#### • LED Settings

The access point's LEDs can be manually enabled or disabled according to your preference.

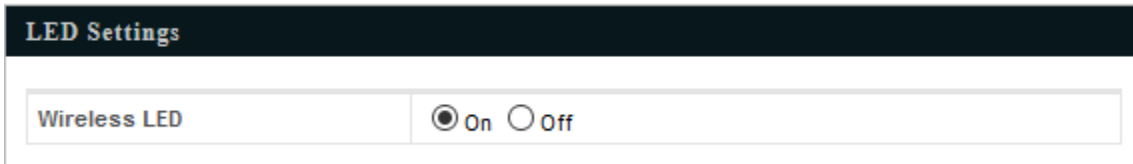

<b>Wireless LED</b>	Select on or off.
---------------------	-------------------

## 4-5-2. Update Firmware

### • Update Firmware

The “Firmware” page allows you to update the system firmware to a more recent version. Updated firmware versions often offer increased performance and security, as well as bug fixes. You can download the latest firmware from the website.

#### Firmware Location

Update firmware from

a file on your PC

a file on an attached USB device (No USB device connected.)

#### Update firmware from PC

Firmware Update File

#### Firmware Location

Update firmware from

a file on your PC

a file on an attached USB device

#### Update firmware from USB

#	Select	Filename	Target	Version	Size (MB)
1	<input type="radio"/>	WAP1750-FW-V1-0-1-1.bin	WAP1750	1.0.1	7



***Do not switch off or disconnect the access point during a firmware upgrade, as this could damage the device.***

<b>Update Firmware From</b>	Select “a file on your PC” to upload firmware from your local computer
-----------------------------	--



<b>Firmware Update File</b>	Click "Browse" to open a new window to locate and select the firmware file in your computer.
<b>Update</b>	Click "Update" to upload the specified firmware file to your access point.

### 4-5-3. Save/Restore Settings

#### • Save/Restore Settings

The access point’s “Save/Restore Settings” page enables you to save/backup the access point’s current settings as a file to your local computer, and restore the access point to previously saved settings.

**Save/Restore Method**

**Using Device**

Using your PC  
 Using your USB device (No USB device connected.)

**Save Settings to PC**

**Save Settings**

Encrypt the configuration file with a password.

**Restore Settings from PC**

**Restore Settings**

No file selected.  
 Open file with password.

Save / Restore Settings	
<b>Using Device</b>	Select “Using your PC” to save the access point’s settings to your local computer

Save Settings to PC	
<b>Save Settings</b>	Click “Save” to save settings and a new window will open to specify a location to save the settings file. You can also check the “Encrypt the configuration file with a password”

	box and enter a password to protect the file in the field underneath, if you wish.
--	--

Restore Settings from PC	
<b>Restore Settings</b>	Click the browse button to find a previously saved settings file on your computer, then click “Restore” to replace your current settings. If your settings file is encrypted with a password, check the “Open file with password” box and enter the password in the field underneath.

#### 4-5-4. Factory Default

##### • Factory Default

If the access point malfunctions or is not responding, then it is recommended that you reboot the device (see 4-5-5) or reset the device back to its factory default settings. You can reset the access point back to its default settings using this feature if the location of the access point is not convenient to access the reset button.

**This will restore all settings to factory defaults.**

Factory Default

##### Factory Default

Click "Factory Default" to restore settings to the factory default. A pop-up window will appear and ask you to confirm.



***After resetting to factory defaults, please wait for the access point to reset and restart.***

#### 4-5-5. Reboot

##### • Reboot

If the access point malfunctions or is not responding, then it is recommended that you reboot the device or reset the access point back to its factory default settings (see **4-5-4**). You can reboot the access point remotely using this feature.

**This will reboot the product. Your settings will not be changed. Click "Reboot" to reboot the product now.**

Reboot

<b>Reboot</b>	Click "Reboot" to reboot the device. A countdown will indicate the progress of the reboot.
---------------	--

### **5-1. Configuring your IP address**

The access point uses the default IP address **192.168.1.230**. In order to access the browser based configuration interface, you need to modify the IP address of your computer to be in the same IP address subnet e.g. **192.168.1.x (x = 1-200)**.

The procedure for modifying your IP address varies across different operating systems; please follow the guide appropriate for your operating system.

In the following examples, we use the IP address **192.168.1.10** though you can use any IP address in the range **192.168.1.x (x = 1 – 100)**.

## 5-1-1. Windows 7

1. Click the “Start” button (it should be located in the lower-left corner of your computer), then click “Control Panel”.

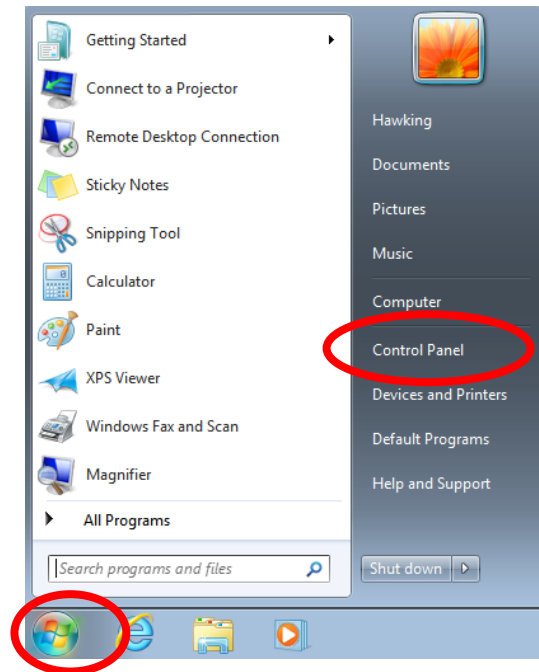

2. Under “Network and Internet” click “View network status and tasks”.

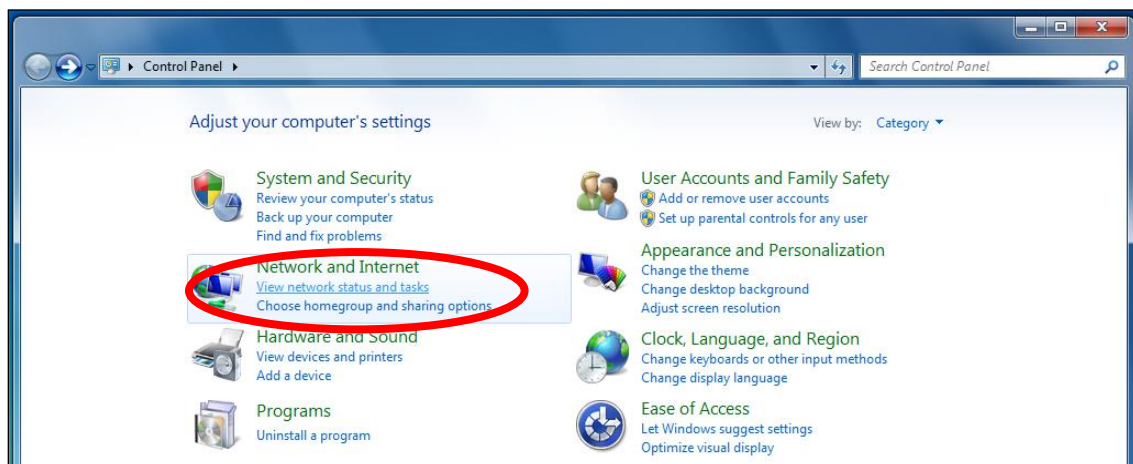

3. Click “Local Area Connection”.

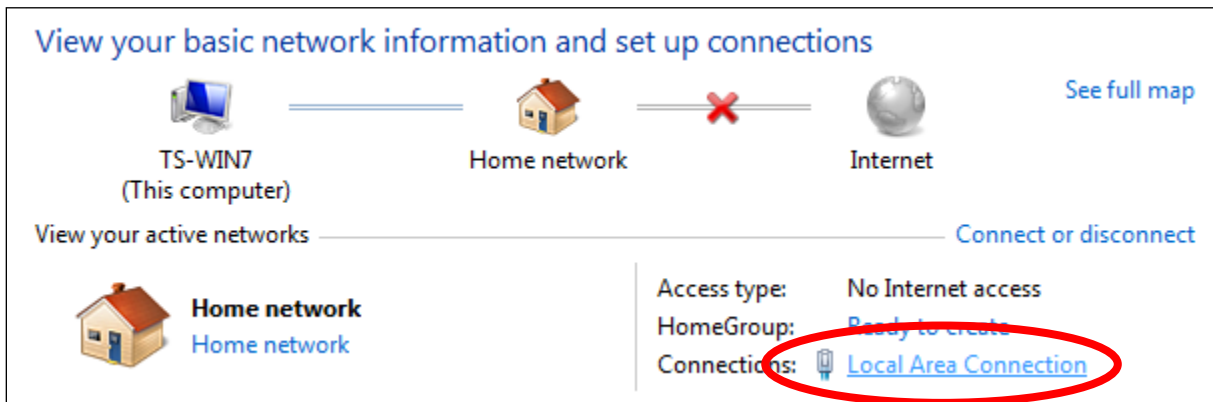

4. Click "Properties".

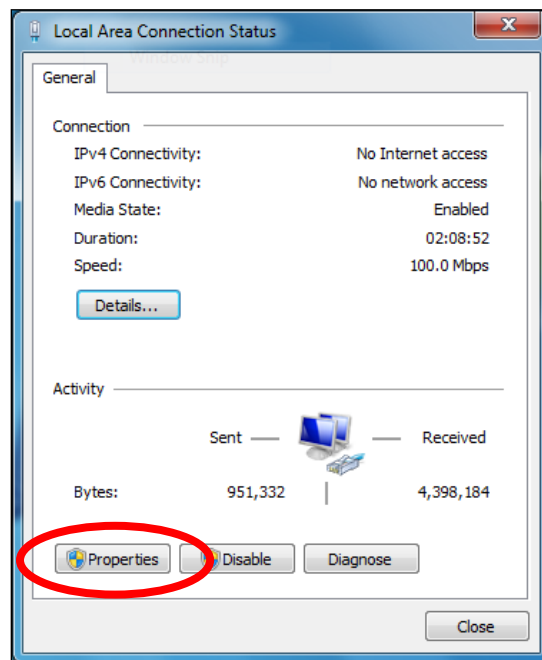



5. Select "Internet Protocol Version 4 (TCP/IPv4)" and then click "Properties".

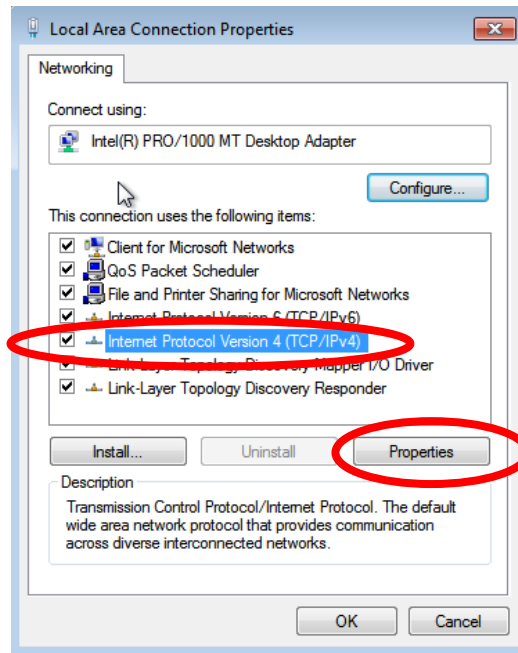

6. Select "Use the following IP address", then input the following values:

**IP address:** 192.168.1.10

**Subnet Mask:** 255.255.255.0

Click 'OK' when finished.

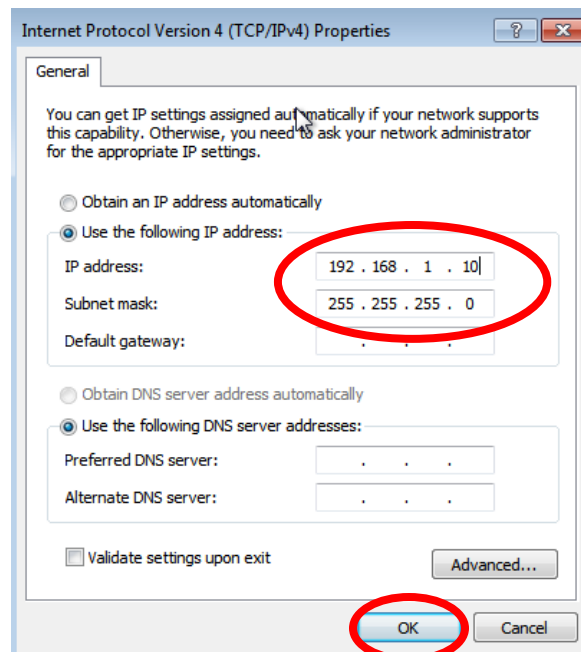

## 5-1-2. Windows 8.1

1. From the Windows 8.1 Start screen, you need to switch to desktop mode. Click on the Desktop icon.

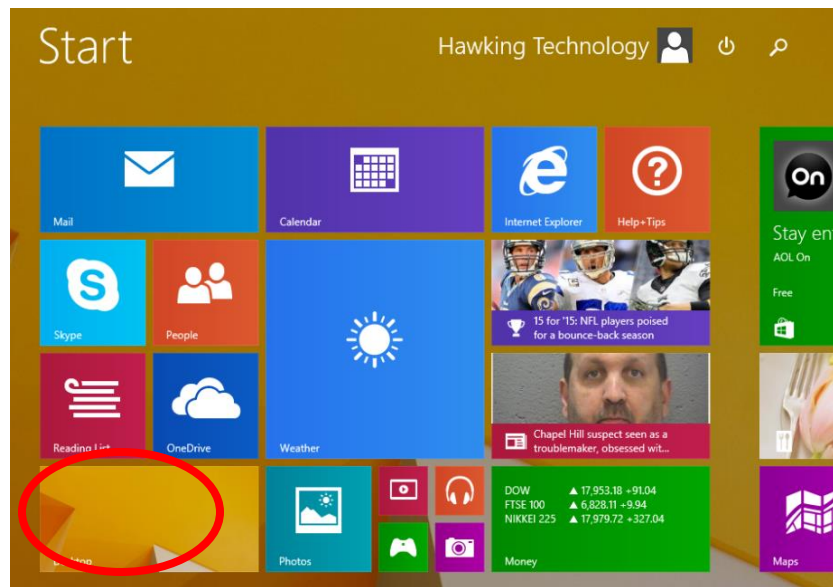

2. In desktop mode, right click on the Start Menu and choose Network Connections

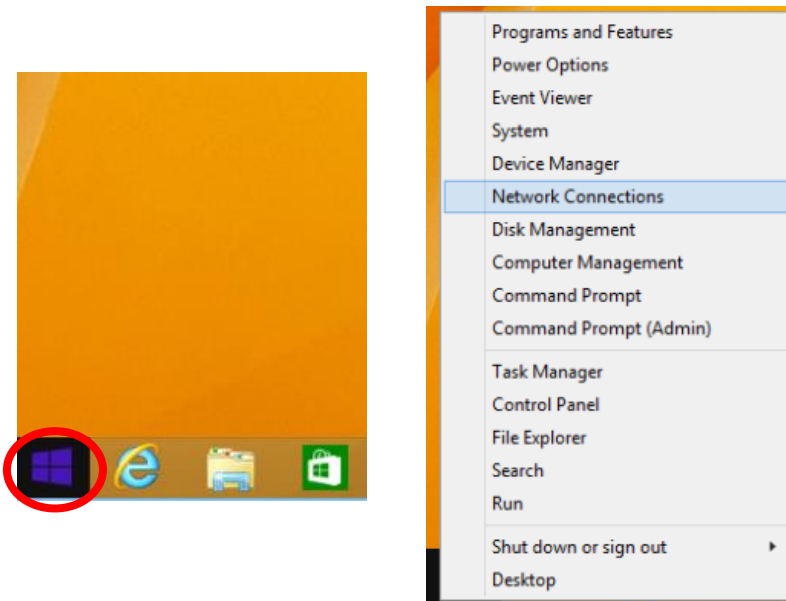

3. Right click "Ethernet" and then select "Properties".

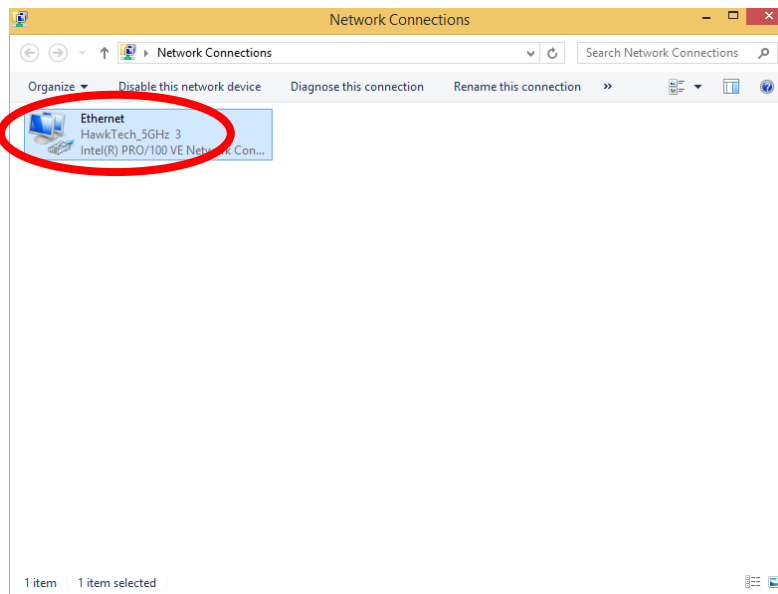

4. In the window that opens, select "Internet Protocol Version 4 (TCP/IPv4)", then click on properties.

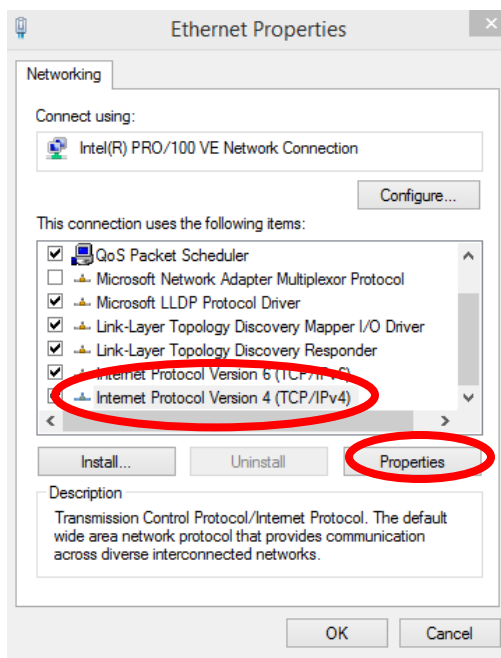

5. Select "Use the following IP address", then input the following values:

**IP address:** 192.168.1.10

**Subnet Mask:** 255.255.255.0

Click 'OK' when finished.

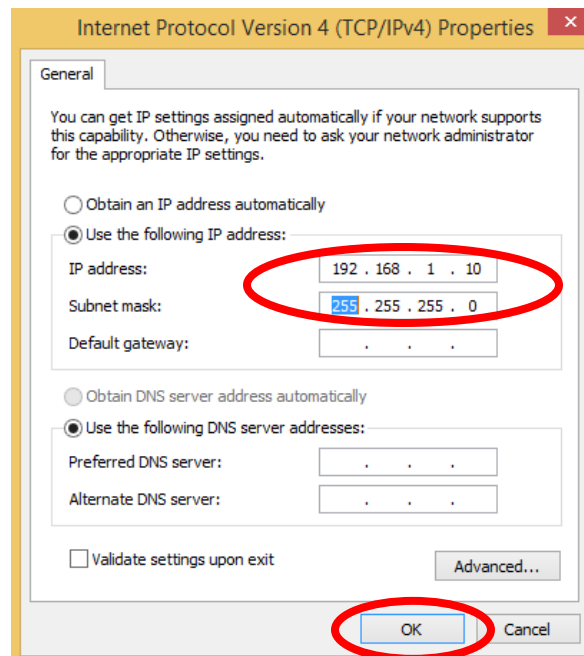

### 5-1-3. Windows 10

**6.** From the Windows 10 Start screen, right click on the Start button.

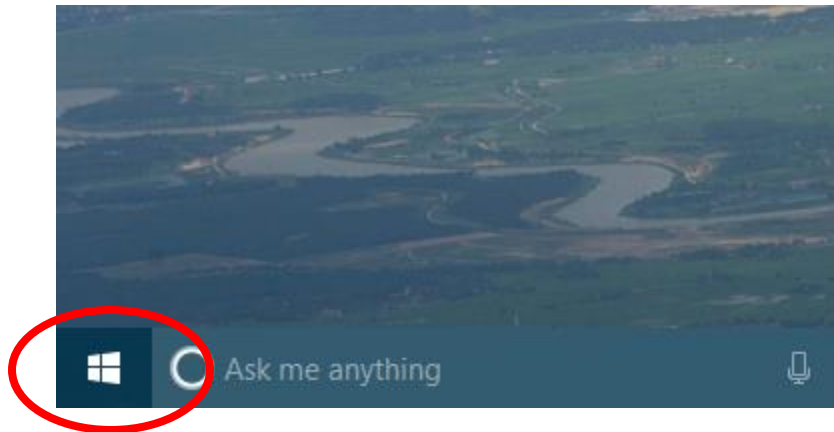

**7.** Select Network Connections

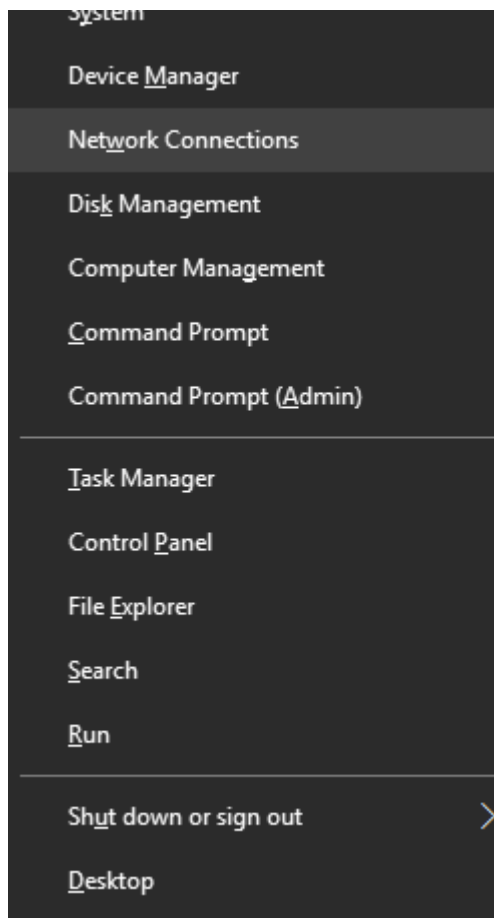

8. Right click “Ethernet” and then select “Properties”.

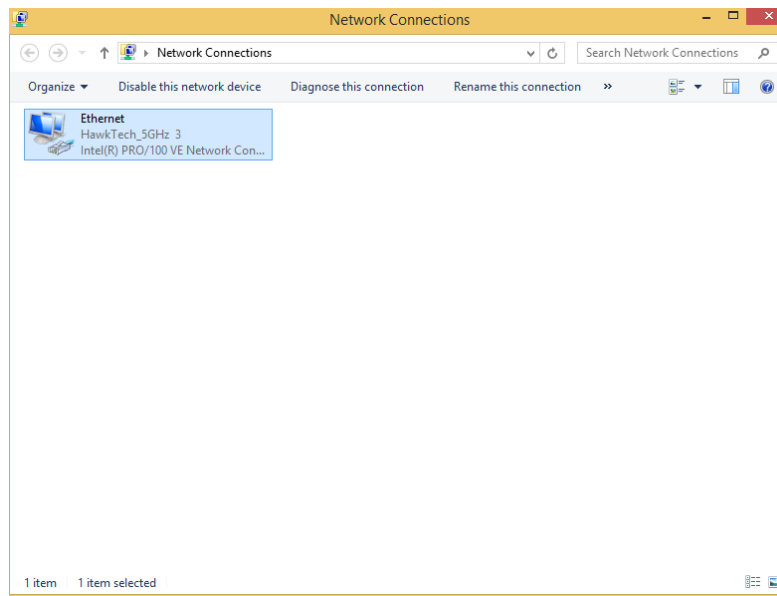

9. In the window that opens, select “Internet Protocol Version 4 (TCP/IPv4)”, then click on properties.

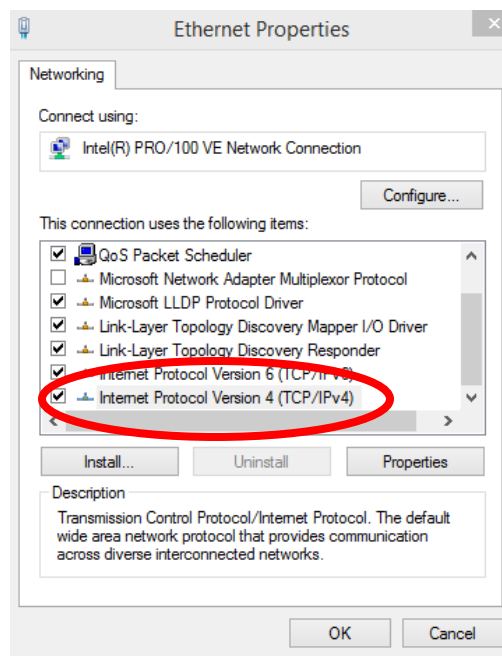

10. Select “Use the following IP address”, then input the following values:

**IP address:** 192.168.1.10

**Subnet Mask:** 255.255.255.0

Click 'OK' when finished.

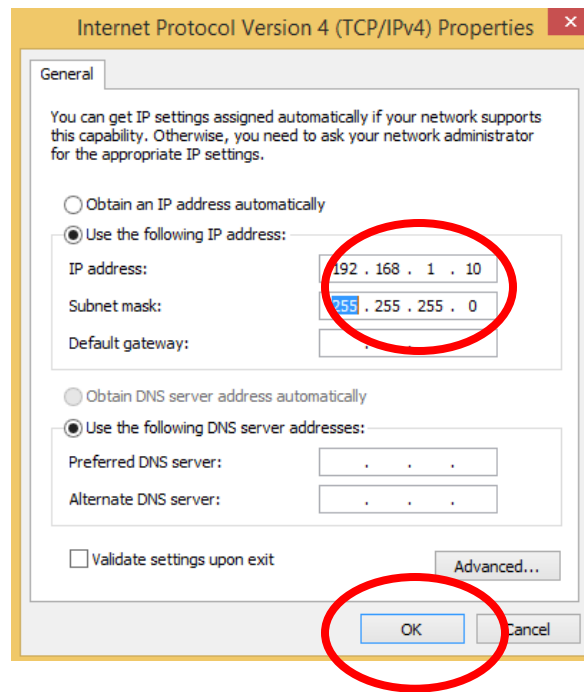

#### 5-1-4. Mac

1. Have your Mac computer operate as usual, and click on "System Preferences"



2. In System Preferences, click on "Network".

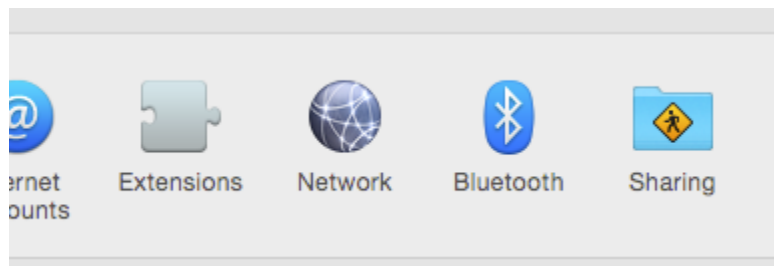

3. Click on “Ethernet” in the left panel. Under configure IPv4, change it to manually. Enter the IP address 192.168.1.10 and subnet mask 255.255.255.0. Click on “Apply” to save the changes.

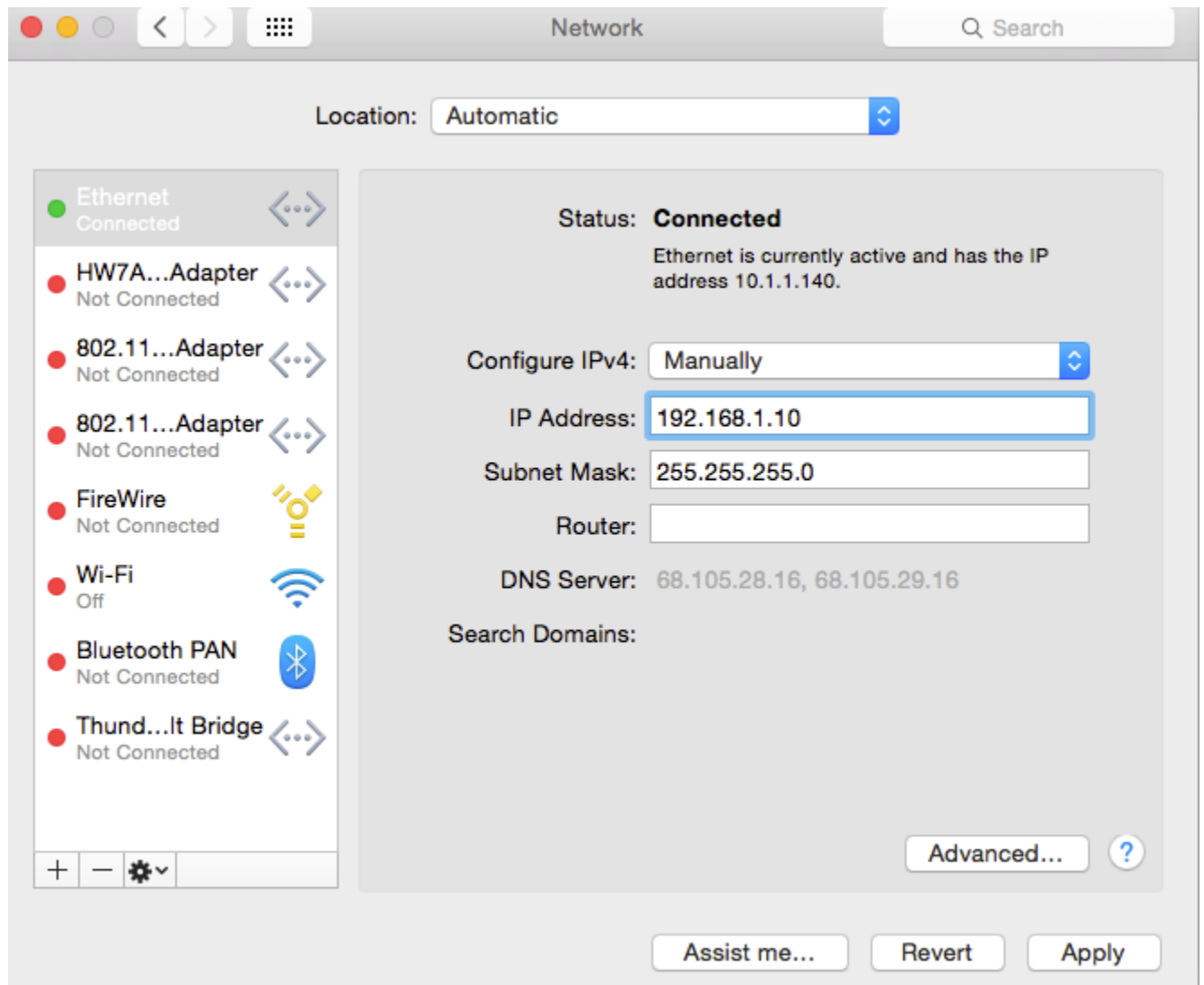



## 5-2. Hardware Specification

MCU/RF	Qualcomm Atheros QCA9558 (2.4GHz) + QCA9880 (5GHz)
PHY/Switch	Qualcomm Atheros AR8035
Memory	DDR2 128MB
Flash	16MB
Physical Interface	<p>-LAN : 1 x 10/100/1000 Gigabit Ethernet with 802.3at PoE support            -3 x LED + 1 x Reset M25 interface</p> 
Power Requirement	Power over Ethernet, IEEE 802.3at
Antenna	<p>External N-Type 2.4G 4dBi Antenna x 3            External N-Type 5G 6dBi Antenna x 3</p>

## 5-3. Environmental and Physical

Temperature Range	<p>Operation :            Using PoE: -40°C to 70°C (-40°F to 158°F)            Storage : -40°C to 80°C (-40°F to 176°F)</p>
Humidity	90% or less – Operating, 95% or less - Storage
Certifications	FCC, CE
Dimensions	256.7mm (L) x 226.7mm(W) x 90.3(H)mm
Weight	2.98Kg

#### 5-4. Glossary

**Default Gateway (Access point):** Every non-access point IP device needs to configure a default gateway's IP address. When the device sends out an IP packet, if the destination is not on the same network, the device has to send the packet to its default gateway, which will then send it out towards the destination.

**DHCP:** Dynamic Host Configuration Protocol. This protocol automatically gives every computer on your home network an IP address.

**DNS Server IP Address:** DNS stands for Domain Name System, which allows Internet servers to have a domain name (such as `www.Broadbandaccess point.com`) and one or more IP addresses (such as `192.34.45.8`). A DNS server keeps a database of Internet servers and their respective domain names and IP addresses, so that when a domain name is requested (as in typing "`Broadbandaccess point.com`" into your Internet browser), the user is sent to the proper IP address. The DNS server IP address used by the computers on your home network is the location of the DNS server your ISP has assigned to you.

**DSL Modem:** DSL stands for Digital Subscriber Line. A DSL modem uses your existing phone lines to transmit data at high speeds.

**Ethernet:** A standard for computer networks. Ethernet networks are connected by special cables and hubs, and move data around at up to 10/100 million bits per second (Mbps).

**IP Address and Network (Subnet) Mask:** IP stands for Internet Protocol. An IP address consists of a series of four numbers separated by periods, that identifies a single, unique Internet computer host in an IP network. Example: `192.168.2.1`. It consists of 2 portions: the IP network address, and the host identifier.

The IP address is a 32-bit binary pattern, which can be represented as four cascaded decimal numbers separated by ".": `aaa.aaa.aaa.aaa`, where each "aaa" can be anything from 000 to 255, or as four cascaded binary numbers separated by ".": `bbbbbbbb.bbbbbbbb.bbbbbbbb.bbbbbbbb`, where each "b" can either be 0 or 1.

A network mask is also a 32-bit binary pattern, and consists of consecutive leading 1's followed by consecutive trailing 0's, such as

`11111111.11111111.11111111.00000000`. Therefore sometimes a network mask can also be described simply as "x" number of leading 1's.

When both are represented side by side in their binary forms, all bits in the IP address that correspond to 1's in the network mask become part of the IP network address, and the remaining bits correspond to the host ID.

For example, if the IP address for a device is, in its binary form, 11011001.10110000.10010000.00000111, and if its network mask is, 11111111.11111111.11110000.00000000

It means the device's network address is 11011001.10110000.10010000.00000000, and its host ID is, 00000000.00000000.00000000.00000111. This is a convenient and efficient method for access points to route IP packets to their destination.

**ISP Gateway Address:** (see ISP for definition). The ISP Gateway Address is an IP address for the Internet access point located at the ISP's office.

**ISP:** Internet Service Provider. An ISP is a business that provides connectivity to the Internet for individuals and other businesses or organizations.

**LAN:** Local Area Network. A LAN is a group of computers and devices connected together in a relatively small area (such as a house or an office). Your home network is considered a LAN.

**MAC Address:** MAC stands for Media Access Control. A MAC address is the hardware address of a device connected to a network. The MAC address is a unique identifier for a device with an Ethernet interface. It is comprised of two parts: 3 bytes of data that corresponds to the Manufacturer ID (unique for each manufacturer), plus 3 bytes that are often used as the product's serial number.

**NAT:** Network Address Translation. This process allows all of the computers on your home network to use one IP address. Using the broadband access point's NAT capability, you can access the Internet from any computer on your home network without having to purchase more IP addresses from your ISP.

**Port:** Network Clients (LAN PC) uses port numbers to distinguish one network application/protocol over another. Below is a list of common applications and protocol/port numbers:

Application	Protocol	Port Number
Telnet	TCP	23
FTP	TCP	21
SMTP	TCP	25
POP3	TCP	110
H.323	TCP	1720
SNMP	UCP	161
SNMP Trap	UDP	162
HTTP	TCP	80

PPTP	TCP	1723
PC Anywhere	TCP	5631
PC Anywhere	UDP	5632

**Access point:** A access point is an intelligent network device that forwards packets between different networks based on network layer address information such as IP addresses.

**Subnet Mask:** A subnet mask, which may be a part of the TCP/IP information provided by your ISP, is a set of four numbers (e.g. 255.255.255.0) configured like an IP address. It is used to create IP address numbers used only within a particular network (as opposed to valid IP address numbers recognized by the Internet, which must be assigned by InterNIC).

**TCP/IP, UDP:** Transmission Control Protocol/Internet Protocol (TCP/IP) and Unreliable Datagram Protocol (UDP). TCP/IP is the standard protocol for data transmission over the Internet. Both TCP and UDP are transport layer protocol. TCP performs proper error detection and error recovery, and thus is reliable. UDP on the other hand is not reliable. They both run on top of the IP (Internet Protocol), a network layer protocol.

**WAN:** Wide Area Network. A network that connects computers located in geographically separate areas (e.g. different buildings, cities, countries). The Internet is a wide area network.

**Web-based management Graphical User Interface (GUI):** Many devices support a graphical user interface that is based on the web browser. This means the user can use the familiar Netscape or Microsoft Internet Explorer to Control/configure or monitor the device being managed.